

Tektronix®

COMMITTED TO EXCELLENCE



METAF

Electronic Solutions – since 1993

**Tektronix
National Marketing Center**
for Product Order Information, contact
your local Tektronix sales representative
or, in the U.S., call

1-800-426-2200 ext 41

In Oregon call collect (503)627-9000 ext 41
Tektronix National Marketing Center
P.O. Box 500 D/S Y6-088, Beaverton, OR 97077

**PLEASE CHECK FOR CHANGE INFORMATION
AT THE REAR OF THIS MANUAL.**

2236 OSCILLOSCOPE OPERATORS

INSTRUCTION MANUAL

Tektronix, Inc.
P.O. Box 500
Beaverton, Oregon 97077


070-4205-00
Product Group 46

Serial Number _____

First Printing JAN 1983
Revised SEP 1984

Copyright © 1983 Tektronix, Inc. All rights reserved.
Contents of this publication may not be reproduced in any
form without the written permission of Tektronix, Inc.

Products of Tektronix, Inc. and its subsidiaries are covered
by U.S. and foreign patents and/or pending patents.

TEKTRONIX, TEK, SCOPE-MOBILE, and  are
registered trademarks of Tektronix, Inc. TELEQUIPMENT
is a registered trademark of Tektronix U.K. Limited.

Printed in U.S.A. Specification and price change privileges
are reserved.

INSTRUMENT SERIAL NUMBERS

Each instrument has a serial number on a panel insert, tag,
or stamped on the chassis. The first number or letter
designates the country of manufacture. The last five digits
of the serial number are assigned sequentially and are
unique to each instrument. Those manufactured in the
United States have six unique digits. The country of
manufacture is identified as follows:

B000000	Tektronix, Inc., Beaverton, Oregon, USA
100000	Tektronix Guernsey, Ltd., Channel Islands
200000	Tektronix United Kingdom, Ltd., London
300000	Sony/Tektronix, Japan
700000	Tektronix Holland, NV, Heerenveen, The Netherlands

TABLE OF CONTENTS

	Page		Page
LIST OF ILLUSTRATIONS	ii	Section 3 OPERATORS FAMILIARIZATION (cont)	
LIST OF TABLES	ii	POWER-UP CHECKS	3-2
OPERATORS SAFETY SUMMARY	iii	CTM MEASUREMENT	
Section 1 GENERAL INFORMATION		CONSIDERATIONS	3-2
INTRODUCTION	1-1	STATUS AND ERRORS MESSAGES	3-2
SPECIFICATION	1-1	OPERATOR'S ADJUSTMENTS	3-4
CALIBRATION	1-18	INTRODUCTION	3-4
REPACKAGING FOR SHIPMENT	1-18	BASELINE TRACE	3-4
		TRACE ROTATION	3-4
		PROBE COMPENSATION	3-5
Section 2 PREPARATION FOR USE		Section 4 OPERATING PROCEDURES	
FIRST-TIME START UP	2-1	BASIC APPLICATIONS	4-1
SAFETY	2-1	INTRODUCTION	4-1
LINE VOLTAGE	2-1	INDEX TO BASIC APPLICATION	
POWER CORD	2-1	PROCEDURES	4-1
LINE FUSE	2-1	VOLTAGE MEASUREMENTS	4-1
INSTRUMENT COOLING	2-2	TELEVISION DISPLAYS	4-4
CONTROLS, CONNECTORS, AND		DELAYED-SWEEP	4-5
INDICATORS	2-2	TIME AND FREQUENCY	
DISPLAY, POWER, AND PROBE		MEASUREMENTS	4-7
ADJUST	2-2	MULTIMETER MEASUREMENTS ..	4-12
VERTICAL	2-3		
HORIZONTAL	2-5	Section 5 OPTIONS AND ACCESSORIES	
TRIGGER	2-6	INTRODUCTION	5-1
COUNTER, TIMER, AND		OPTION 14	5-1
MULTIMETER	2-8	POWER CORD OPTIONS	5-1
RIGHT SIDE PANEL	2-9	STANDARD ACCESSORIES	5-1
REAR PANEL	2-9	OPTIONAL ACCESSORIES	5-1
Section 3 OPERATORS FAMILIARIZATION		FRONT PANEL ILLUSTRATION	
GENERAL OPERATING INFORMATION	3-1	CHANGE INFORMATION	
GRATICULE	3-1		
GROUNDING	3-1		
SIGNAL CONNECTIONS	3-1		
INPUT COUPLING CAPACITOR			
PRECHARGING	3-1		

LIST OF ILLUSTRATIONS

Fig. No.		Page
1-1	Maximum input voltage vs frequency derating curve for CH 1 OR X & DMM, CH 2 OR Y, and EXT INPUT connectors . .	1-16
1-2	Physical dimensions of the 2236 Oscilloscope	1-17
2-1	Optional power cords	2-1
2-2	Fuse holder and power cord connector . . .	2-2
2-3	Power and display controls and indicators and PROBE ADJUST output	2-3
2-4	Vertical controls and connectors	2-3
2-5	Horizontal controls	2-5
2-6	Trigger controls, connector, and indicator .	2-6
2-7	Counter, timer, and multimeter controls and indicator	2-8
2-8	Multimeter right side panel connectors	2-10
2-9	Rear panel connector	2-10
3-1	Graticule measurement markings	3-1
3-2	Probe compensation	3-5
4-1	Peak-to-peak waveform voltage	4-2
4-2	Instantaneous voltage measurement	4-3
4-3	Common-mode rejection	4-4
4-4	Voltage ratios	4-4
4-5	Delayed-sweep magnification	4-6
4-6	Pulse jitter	4-7
4-7	Rise time	4-9
4-8	Time difference between points on two time-related signals in nontriggered mode .	4-10
4-9	Resistance measurement technique	4-13
4-10	Reverse voltage drop to reverse leakage current characteristics for typical semiconductor	4-13

LIST OF TABLES

Table No.		Page
1-1	Electrical Characteristics	1-1
1-2	Environmental Characteristics	1-15
1-3	Physical Characteristics	1-16
2-1	VERT MODE Trigger Source	2-7
3-1	Power-up Checks	3-2
3-2	Equipment Required for 10X Probe Compensation	3-5
4-1	Multimeter Connections to Forward Bias Semiconductors	4-12
4-2	Reference Resistance Values	4-13

OPERATORS SAFETY SUMMARY

The general safety information in this part of the summary is for both operating and servicing personnel. Specific warnings and cautions will be found throughout the manual where they apply and do not appear in this summary.

Terms in This Manual

CAUTION statements identify conditions or practices that could result in damage to the equipment or other property.

WARNING statements identify conditions or practices that could result in personal injury or loss of life.

Terms as Marked on Equipment

CAUTION indicates a personal injury hazard not immediately accessible as one reads the markings, or a hazard to property, including the equipment itself.

DANGER indicates a personal injury hazard immediately accessible as one reads the marking.

Symbols in This Manual



This symbol indicates where applicable cautionary or other information is to be found. For maximum input voltage see Table 1-1.

Symbols As Marked on Equipment



DANGER — High voltage.



Protective ground (earth) terminal.



ATTENTION — Refer to manual.

Power Source

This product is intended to operate from a power source that does not apply more than 250 volts rms between the supply conductors or between either supply conductor and ground. A protective ground connection by way of the grounding conductor in the power cord is essential for safe operation.

Grounding the Product

This product is grounded through the grounding conductor of the power cord. To avoid electrical shock, plug the power cord into a properly wired receptacle before connecting to the product input or output terminals. A protective ground connection by way of the grounding conductor in the power cord is essential for safe operation.

Danger Arising From Loss of Ground

Upon loss of the protective-ground connection, all accessible conductive parts (including knobs and controls that may appear to be insulating) can render an electric shock.

Use the Proper Power Cord

Use only the power cord and connector specified for your product.

Use only a power cord that is in good condition.

For detailed information on power cords and connectors see Figure 2-1.

Use the Proper Fuse

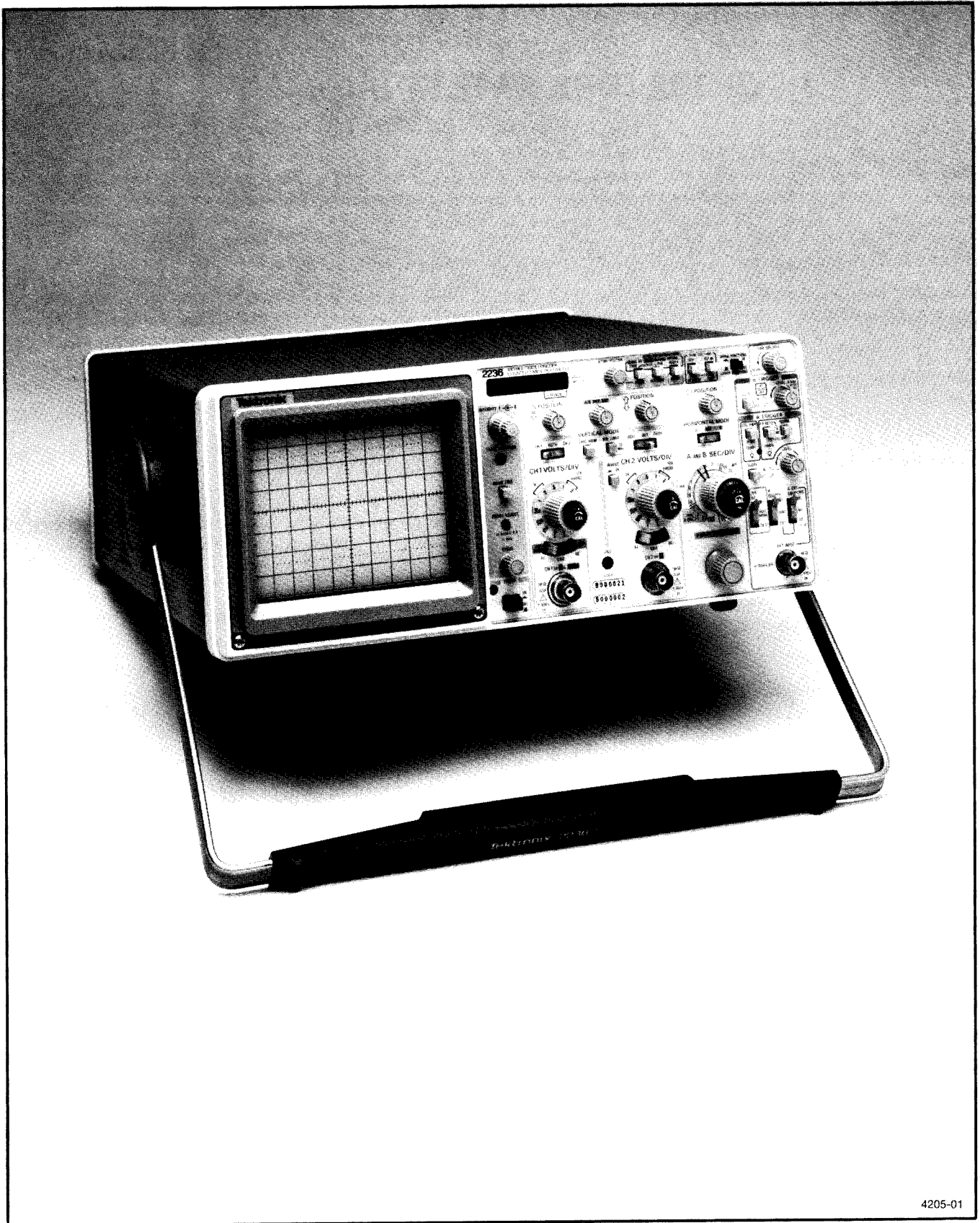
To avoid fire hazard, use only a fuse of the correct type, voltage rating and current rating as specified in the parts list for your product.

Do Not Operate in Explosive Atmospheres

To avoid explosion, do not operate this product in an explosive atmosphere unless it has been specifically certified for such operation.

Do Not Remove Covers or Panels

To avoid personal injury, do not remove the product covers or panels. Do not operate the product without the covers and panels properly installed.



4205-01

The 2236 Oscilloscope.

GENERAL INFORMATION

INTRODUCTION

The TEKTRONIX 2236 oscilloscope is a lightweight 100-MHz instrument with a Counter, Timer, and Multimeter (CTM). Measurement values are displayed on the Vacuum Fluorescent nine-digit readout.

The dual vertical channel system supplies calibrated deflection factors from 2 mV per division to 5 V per division. Trigger circuits enable stable triggering over the full bandwidth of the vertical system. The horizontal system provides calibrated sweep speeds from 0.5 s per division to 50 ns per division, along with delayed-sweep features. A X10 magnifier circuit extends the maximum sweep speed to 5 ns per division when the A and B SEC/DIV switch is set to 0.05 μ s.

The Counter Timer section of the CTM measures frequency, period, width, and totalizes, and provides a digital readout of oscilloscope delay time and delta time. It also provides frequency, period, and width measurements and totalizes on portions of a waveform selected by the intensified zone (gated measurements). Counting and timing measurements are made through the A and B Trigger system. All Counter Timer measurement values are displayed on the readout.

The Multimeter section of the CTM measures voltages and resistance through the floating input connectors located on the right side of the instrument. Voltages can also be measured through the CH 1 or X & DMM connector. Temperature measurements can be made by connecting the optional temperature probe to the Multimeter input connectors. The Multimeter measurement values are displayed with a 3 3/4-digit (5000 count) format, on the digital readout.

The instrument is shipped with the following standard accessories:

1 Operators manual	2 Multimeter test lead clips
1 Probe package	2 Multimeter test leads
	1 Power cord

For part numbers and further information about both standard and optional accessories, refer to the "Options and Accessories" section (Section 5) of this manual. Your Tektronix representative, local Tektronix Field Office, or Tektronix product catalog can also provide accessories information.

SPECIFICATION

The following electrical characteristics (Table 1-1) are valid for the 2236 when it has been adjusted at an ambient temperature between +20°C and +30°C, has had a warm-up period of at least 30 minutes, and is operating at an ambient temperature between 0°C and +50°C (unless otherwise noted).

Items listed in the "Performance Requirements" column are verifiable qualitative or quantitative limits, while items listed in the "Supplemental Information" column are either explanatory notes, calibration setup descriptions, performance characteristics for which no absolute limits are specified, or characteristics that are impractical to check.


Environmental characteristics are given in Table 1-2. The 2236 meets the requirements of MIL-T-28800C, paragraphs 4.5.5.1.3, 4.5.5.1.4, and 4.5.5.1.2.2 for Type III, Class 5 equipment, except where otherwise noted.

Physical characteristics of the instrument are listed in Table 1-3.

**Table 1-1
Electrical Characteristics**


Characteristics	Performance Requirements	Supplemental Information
VERTICAL DEFLECTION SYSTEM		
Deflection Factor		5 mV per division to 5 V per division gain is adjusted with VOLTS/DIV switch set to 10 mV per division. 2 mV per division gain is adjusted with VOLTS/DIV switch set to 2 mV per division
Range	2 mV per division to 5 V per division in a 1-2-5 sequence	
Accuracy		
+15°C to +35°C	±2%.	
0°C to +50°C	±3%.	
Range of VOLTS/DIV Variable Control	Continuously variable between settings. Increases deflection factor by at least 2.5 to 1.	
Step Response		Rise time is calculated from the formula: $\frac{0.35}{\text{Bandwidth } (-3 \text{ dB})}$
Rise Time		
0°C to +35°C		
5 mV per Division to 5 V per Division	3.5 ns or less.	
2 mV per Division	3.9 ns or less.	
+35°C to +50°C		
5 mV per Division to 5 V per Division	3.9 ns or less.	
2 mV per Division	4.4 ns or less.	
Aberrations		Measured with 5-division reference signal, centered vertically, from a 50 Ω source driving a 50 Ω coaxial cable terminated in 50 Ω at the input connector with the VOLTS/DIV Variable control in the CAL detent.
Positive-Going Step		
5 mV per Division to 0.5 V per Division	+4%, -4%, 4% p-p.	
2 mV per Division	+5%, -5%, 5% p-p.	
1 V per Division to 5 V per Division	+12%, -12%, 12% p-p.	
Bandwidth (-3 dB)		Measured with a vertically centered 6-division reference signal from a 50 Ω source driving a 50 Ω coaxial cable that is terminated in 50 Ω, both at the input connector and at the probe input, with the VOLTS/DIV Variable control in the CAL detent.
0°C to +35°C		
5 mV per Division to 5 V per Division	Dc to at least 100 MHz.	
2 mV per Division	Dc to at least 90 MHz.	
+35°C to +50°C		
5 mV per Division to 5 V per Division.	Dc to at least 90 MHz.	
2 mV per Division	Dc to at least 80 MHz.	
AC Coupled Lower Limit	10 Hz or less at -3 dB.	

Table 1-1 (cont)

Characteristics	Performance Requirements	Supplemental Information
VERTICAL DEFLECTION SYSTEM (cont)		
Bandwidth Limiter	Upper limits (-3 dB) bandpass at 20 MHz $\pm 10\%$.	
Chop Mode Switching Rate	500 kHz $\pm 30\%$.	
Input Characteristics		
Resistance		
Channel 1	1 M Ω $\pm 0.2\%$.	
Channel 2	1 M Ω $\pm 2\%$	
Capacitance (Channels 1 and 2)	22 pF ± 0.5 pF.	
Maximum Safe Input Voltage 		
DC Coupled	400 V (dc + peak ac) or 800 V ac p-p to 10 kHz or less. ^a	
AC Coupled	400 V (dc + peak ac) or 800 V ac p-p to 10 kHz or less. ^a	
Common-Mode Rejection Ratio (CMRR)	At least 10 to 1 at 50 MHz.	Checked at 10 mV per division for common-mode signals of 6 divisions or less with VOLTS/DIV Variable control adjusted for best CMRR at 50 kHz.
Input Current	1.0 nA or less (0.5 division trace shift at 2 mV per division).	
Trace Shift with Attenuator Rotation	0.75 division or less.	VOLTS/DIV Variable control in CAL detent.
Trace Shift as VOLTS/DIV Variable Control is Rotated	1.0 division or less.	
Trace Shift with Invert	1.5 division or less.	
Channel Isolation	Greater than 100 to 1 at 50 MHz.	
POSITION Control Range	At least ± 11 divisions from graticule center.	

^aSee Figure 1-1 for derating curve.

Table 1-1 (cont)

Characteristics	Performance Requirements			Supplemental Information
TRIGGER SYSTEM				
A TRIGGER Sensitivity				External trigger signal from a 50 Ω source driving a 50 Ω coaxial cable terminated in 50 Ω at the input connector. Trigger sensitivities define signal amplitude required for stable display.
P-P AUTO and NORM Modes	10 MHz	60 MHz	100 MHz	
A Sweep				
Internal	0.35 div	1.2 div	1.5 div	
External	40 mV	150 mV	250 mV	
Counter				
Internal	0.5 div	1.5 div	2.0 div	
External	50 mV	160 mV	300 mV	
Lowest Useable Frequency in P-P AUTO Mode	20 Hz with 1.0 division internal or 100 mV external.			
TV FIELD Mode	1.0 division of composite sync.			
B TRIGGER Sensitivity (Internal Only)	10 MHz	60 MHz	100 MHz	
B Sweep	0.35 div	1.2 div	1.5 div	
Counter	0.5 div	1.6 div	2.0 div	
EXT INPUT				
Maximum Input Voltage 	400 V (dc + peak ac) or 800 V ac p-p at 10 kHz or less. ^a			
Input Resistance	1 MΩ ± 2%.			
Input Capacitance	22 pF ± 2.5 pF.			
AC Coupled	10 Hz or less at lower –3 dB point.			
Offset	25 mV or less.			
LEVEL Control Range				
A TRIGGER (NORM)				
INT	Can be set to any point of the trace that can be displayed.			
EXT, DC	At least ± 1.6 V, 3.2 V p-p.			
EXT, DC ÷ 10	At least ± 16 V, 32 V p-p.			
B TRIGGER (Internal only)	Can be set to any point of the trace that can be displayed.			
VAR HOLDOFF Control	Increases A Sweep holdoff time by at least a factor of 10.			

^aSee Figure 1-1 for derating curve.

Table 1-1 (cont)

Characteristics	Performance Requirements		Supplemental Information
TRIGGER SYSTEM (cont)			
LEVEL Control Range (cont)			
Trigger View System			
Deflection Factor			
Internal	Same as vertical.		
External			
AC and DC	100 mV per division.		
DC ÷ 10	1 V per division.		
Accuracy	± 20%.		
Delay Difference Between EXT INPUT and Either Vertical Channel	Less than 2.0 ns.		
HORIZONTAL DEFLECTION SYSTEM			
Sweep Rate			
Calibrated Range			
A Sweep	0.5 s per division to 0.05 μs per division in a 1-2-5 sequence. X10 magnifier extends maximum sweep speed to 5 ns per division.		
B Sweep	50 ms per division to 0.05 μs per division in a 1-2-5 sequence. X10 magnifier extends maximum sweep speed to 5 ns per division.		
Accuracy	Unmagnified	Magnified	Sweep accuracy applies over the center 8 divisions. Exclude the first 25 ns of the sweep for magnified sweep speeds and anything beyond the 100th magnified division.
+15°C to +35°C	± 2%	± 3%	
0°C to +50°C	± 3%	± 4%	
POSITION Control Range	Start of sweep to 10th division will position past the center vertical graticule line in X1 or 100th division in X10.		
Sweep Linearity	± 5%.		Linearity measured over any 2 of the center 8 divisions. With magnifier in X10, exclude the first 25 ns and anything past the 100th division.
Variable Control Range	Continuously variable between calibrated settings. Extends the A and B sweep speeds by at least a factor of 2.5.		
Sweep Length	Greater than 10 division.		
A/B SWP SEP Range	± 3.5 divisions or greater.		

Table 1-1 (cont)

Characteristics	Performance Requirements	Supplemental Information
HORIZONTAL DEFLECTION SYSTEM (cont)		
Delay Time		
Dial Control Range	<0.5 +300 ns to >10 divisions.	
Jitter	One part or less in 10,000 (0.01%) of the maximum available delay time.	
X-Y OPERATION (X1 MAGNIFICATION)		
Deflection Factors	Same as Vertical Deflection System (with VOLTS/DIV Variable controls in CAL detent).	
Accuracy		Measured with a dc-coupled, 5-division reference signal.
X-Axis		
+15°C to +35°C	±3%.	
0°C to +50°C	±4%.	
Y-Axis	Same as Vertical Deflection System.	
Bandwidth (–3 dB)		Measured with a 5-division reference signal.
X-Axis	Dc to at least 3 MHz.	
Y-Axis	Same as Vertical Deflection System.	
Phase Difference Between X- and Y-Axis Amplifiers	±3° from dc to 50 kHz.	With dc-coupled inputs.
PROBE ADJUST		
Output Voltage of PROBE ADJUST Jack	0.5 V ±5%.	
Repetition Rate	1 kHz ±20%.	
Z-AXIS INPUT		
Sensitivity	5 V causes noticeable modulation. Positive-going input decreases intensity.	Useable frequency range is dc to 20 MHz.
Maximum Safe Input Voltage	30 V (dc + peak ac) or 30 V p-p ac at 1 kHz or less.	
Input Resistance	10 kΩ ±10%.	

Table 1-1 (cont)

Characteristics	Performance Requirements	Supplemental Information
COUNTER-TIMER		
Frequency	Ranges	Maximum Resolution
	100 Hz	0.00001 Hz
	1 kHz	0.0001 Hz
	10 kHz	0.001 Hz
	100 kHz	0.01 Hz
	1 MHz	0.1 Hz
	10 MHz	1 Hz
	100 MHz	10 Hz
Maximum Input Frequency	Same as trigger specifications.	
Minimum Displayable Frequency	0.20000 Hz.	
Time Base Error		
Standard	± 1 X 10 ⁻⁵ (10 parts per million) Less than 5 X 10 ⁻⁶ change per year.	
Option 14	± 5 X 10 ⁻⁷ (0.5 parts per million.) Less than 1 X 10 ⁻⁷ change per month.	
Nongated Mode (Hz)		
Resolution Error	$\left[\pm \left(\frac{1.4 \text{ TJE}}{N} \right) F^2 \pm \text{LSD} \right]^b$	
Accuracy	Resolution Error ± (TBE)F	
Gated Mode (Hz)		
Resolution Error	$\left[\pm \left(\frac{1.4 \text{ TJE}}{N_g} \right) F^2 \pm \text{LSD} \right]^b$	
Accuracy	Resolution Error ± Frequency Gating Error ± (TBE)F.	
Gating Error	$\left(\frac{2 \text{ ns}}{N_g} \right) F^2$	

^bReduces to ± LSD for pulse inputs with transition times ≤ 20 ns.

TJE = Trigger jitter error (seconds).

F = Frequency of input (Hz).

N = Number of input samples accumulated = F(0.25 second ± 0.01 second) ≥ 1.

LSD = One count in least significant digit.

TBE = Time base error (fractional).

N_g = Number of samples inside one gate interval ≥ 1.

Table 1-1 (cont)

Characteristics	Performance Requirements	Supplemental Information
COUNTER-TIMER (cont)		
Period	Ranges	Maximum Resolution
	5 s	1 μs
	1 s	100 ns
	100 ms	10 ns
	10 ms	1 ns
	1 ms	100 ps
	100 μs	10 ps
Minimum Input Period	See trigger specifications.	
Maximum Displayable Period	5 seconds.	
Nongated Mode (seconds)		
Resolution Error	$\left[\pm \left(\frac{1.4 \text{ TJE}}{N} \right) \pm \text{LSD} \right]^b$	
Accuracy	Resolution Error ± (TBE)P.	
Gated Mode (seconds)		
Resolution Error	$\left[\pm \left(\frac{1.4 \text{ TJE}}{N_g \sqrt{G}} \right) \pm \text{LSD} \right]^b$	
Accuracy	Resolution Error ± Time Interval Gating Error ± (TBE)P.	
Time Interval Gating Error	$\frac{2 \text{ ns}}{N_g}$	
Width	Ranges	Maximum Resolution
	5 s	1 μs
	1 s	100 ns
	100 ms	10 ns
	10 ms	1 ns
	1 ms	100 ps
	100 μs	10 ps
Minimum Input Width	5 ns.	
Maximum Displayable Width	5 seconds.	

G = Number of gate intervals in one measurement = (A sweep repetition rate) (0.25 second ± 0.01 second) ≥ 1.

P = Period of input (seconds).

Table 1-1 (cont)

Characteristics	Performance Requirements		Supplemental Information
COUNTER-TIMER (cont)			
Width (cont)			
Nongated Mode (seconds)			
Resolution Error	$\left[\pm \frac{1}{\sqrt{N}} (\text{TJE of leading edge} \pm \text{TJE of trailing edge}) \pm \frac{10 \text{ ns}}{\sqrt{N}} \right]^c$		
Accuracy	Resolution Error \pm (TBE)W \pm Hysteresis Error \pm 10 ns.		Checked in A TRIGGER NORM MODE.
Gated Mode (seconds)			
Accuracy	Resolution Error ^d \pm (TBE)W \pm Hysteresis Error \pm Time Interval Gating Error \pm 10 ns.		
Hysteresis			
Error (seconds)	$\left[\frac{\text{Sensitivity}}{2} \left(\frac{1}{\text{slew rate of trailing edge}} - \frac{1}{\text{slew rate of leading edge}} \right) \right]^e$		Slew rate expressed in divisions on screen.
Sensitivity	See A and B TRIGGER sensitivities expressed in divisions on screen.		
Delay Time	Ranges	Maximum Resolution	
	5 s	1 μ s	
	1 s	100 ns	
	100 ms	10 ns	
	10 ms	1 ns	
	1 ms	100 ps	
	100 μ s	10 ps	
Minimum Displayable Delay Time	500 ns.		
Maximum Displayable Delay Time	2.5 seconds.		
B Runs After Delay (seconds)			
Resolution Error	$\pm \left(\frac{\text{delay time jitter}}{\sqrt{G}} \right) \pm \frac{10 \text{ ns}}{\sqrt{G}}$		
Accuracy	Resolution Error \pm (TBE)Td \pm 20 ns.		

^cReduces to $\pm 10 \text{ nsec}$ for pulse inputs with transition times $\leq 20 \text{ ns}$.
 \sqrt{G}

^dSame as resolution error in nongated mode.

^eReduces to 5 ns for pulse inputs with transition times $\leq 20 \text{ ns}$ and trigger level centered on waveform.

W = Width being measured in seconds.

Td = Delay time being measured in seconds.

Table 1-1 (cont)

Characteristics	Performance Requirements	Supplemental Information														
COUNTER-TIMER (cont)																
Delay Time (cont)																
B Triggered After Delay (seconds)																
Resolution Error	$\left[\pm \frac{1}{\sqrt{G}} (\text{TJE of leading edge} \pm \text{TJE of trailing edge}) \right] \pm \frac{10 \text{ ns}}{\sqrt{G}}$															
Accuracy	Resolution Error \pm (TBE)Td \pm 20 ns.															
Delta Time	<table border="1" style="width: 100%; text-align: center;"> <thead> <tr> <th>Ranges</th> <th>Maximum Resolution</th> </tr> </thead> <tbody> <tr> <td>5 s</td> <td>1 μs</td> </tr> <tr> <td>1 s</td> <td>100 ns</td> </tr> <tr> <td>100 ms</td> <td>10 ns</td> </tr> <tr> <td>10 ms</td> <td>1 ns</td> </tr> <tr> <td>1 ms</td> <td>100 ps</td> </tr> <tr> <td>100 μs</td> <td>10 ps</td> </tr> </tbody> </table>	Ranges	Maximum Resolution	5 s	1 μ s	1 s	100 ns	100 ms	10 ns	10 ms	1 ns	1 ms	100 ps	100 μ s	10 ps	
Ranges	Maximum Resolution															
5 s	1 μ s															
1 s	100 ns															
100 ms	10 ns															
10 ms	1 ns															
1 ms	100 ps															
100 μ s	10 ps															
Maximum Displayable Delta Time	2.5 seconds															
B Runs After Delay (seconds)																
Resolution Error	$\pm \left(\frac{2(\text{delay time jitter})}{\sqrt{G}} \right) \pm \frac{10 \text{ ns}}{\sqrt{G}}$															
Accuracy	Resolution Error \pm (TBE)T Δ .															
B Triggered After Delay With VERTICAL MODE Switch in CH 1, CH 2, ADD, and CHOP (seconds)																
Resolution Error	$\left[\pm \frac{1}{\sqrt{G}} (\text{TJE of leading edge} \pm \text{TJE of trailing edge}) \pm \frac{10 \text{ ns}}{\sqrt{N}} \right]^{\dagger}$															
Accuracy	Resolution Error \pm (TBE)T Δ \pm 50 ps.															
Resolution and Accuracy Definitions																
Trigger Jitter Error (TJE), Through Vertical Input Connectors (in seconds)	$\frac{\sqrt{(e_{n1})^2 + (e_{n2})^2}}{\text{Slew rate of triggering edge}}$	Slew rate expressed in divisions on screen per second.														

[†]Reduces to $\pm \frac{10 \text{ nsec}}{\sqrt{G}}$ for pulse inputs with transition times $\leq 20 \text{ ns}$.

T Δ = Delta time being measured in seconds.

e_{n1} = RMS noise of vertical system (in divisions on screen).

e_{n2} = RMS noise voltage of input signal (in divisions on screen).

Table 1-1 (cont)

Characteristics	Performance Requirements		Supplemental Information
COUNTER-TIMER (cont)			
Resolution and Accuracy Definitions (cont) Value of e_{n1} (divisions, RMS)			
	BW LIMIT On	BW LIMIT Off	
	0.08	0.1	
	0.04	0.05	
2 mV per Division			
5 mV per Division to 5 V per Division			
MULTIMETER			
DC Volts	Ranges	Resolution	
	0.5 V	100 μ V	
	5 V	1 mV	
	50 V	10 mV	
	500 V	100 mV	
Display Update Rate			≥ 2.5 per second.
Accuracy	$\pm (0.1\% \text{ of reading} + 1 \text{ LSD}).$		
	$\pm (0.2\% \text{ of reading} + 4 \text{ LSDs}).$		
+18°C to +28°C			
0°C to +18°C and +28°C to +40°C.			
Normal Mode Rejection	≥ 50 dB from 48 Hz to 62 Hz.		
RMS Volts (AC Coupled)	Ranges	Resolution	
	0.5 V	100 μ V	
	5 V	1 mV	
	50 V	10 mV	
	350 V	100 mV	
Display Update Rate			≥ 2.5 per second.
Accuracy (20 Hz to 20 kHz)	$\pm (1.0\% \text{ of reading} + 6 \text{ LSDs}).$		
	$\pm (1.5\% \text{ of reading} + 8 \text{ LSDs}).$		
+18°C to +28°C			
0°C to +18°C and +28°C to +40°C			
Common Mode Rejection	≥ 60 dB from 48 Hz to 62 Hz.		
Crest Factor	≤ 3.0 to maintain stated accuracy.		
Resistance	Ranges	Resolution	
	50 Ω	0.01 Ω	
	500 Ω	0.1 Ω	
	5 K Ω	1 Ω	
	50 K Ω	10 Ω	
	500 K Ω	100 Ω	
	5 M Ω	1 K Ω	
	50 M Ω	10 K Ω	
	200 M Ω	100 K Ω	
	2 G Ω	10 M Ω	

Table 1-1 (cont)

Characteristics	Performance Requirements				Supplemental Information
MULTIMETER (cont)					
Resistance (cont)					
Display Update Rate					≥2.5 per second.
Overrange Indication (Resistance ≥2 GΩ)	Display indicates "OPEN".				
Diode Detection (Fully Automatic)					
Detectable Forward Voltage Drop	0.15 volts to 2.0 volts.				
Minimum Shunt Resistance	≥2000 Ω per volt of forward drop.				Resistance shunts detectable device.
Maximum Series Resistance	400 Ω per volt of forward drop.				Resistance is in series with detectable device.
Forward Drop Measurement Accuracy	±(1% of reading + 1 LSD).				
Accuracy	50 Ω	500 Ω to 50 MΩ	200 MΩ	2 GΩ	
+18°C to +28°C	±(0.3% of reading +20 LSDs)	±(0.15% of reading +2 LSDs)	±(1.0% of reading +1 LSD)	±(10.0% of reading +1 LSD)	
0°C to +18°C and +28°C to +40°C	±(0.5% of reading +22 LSDs)	±(0.2% of reading +4 LSDs)	±(1.5% of reading +2 LSDs)	±(15.0% of reading +2 LSDs)	
Continuity	With less than 5.0 Ω ± 1 Ω measured, an audible tone will be generated.				
Temperature					With the temperature probe not plugged in, the readout will display "ProbE-?"
Probe Tip Measurement Range	-62°C to +240°C in one range.				
Resolution					0.1° (C or F).
Display Update Rate					≥0.9 per second.
Accuracy (At these Instrument Ambient Temperatures)					No special calibration required for temperature probe (P6602).
+18°C to +28°C	±(2% of reading ± 1.5°C) or ±(2% of reading ± 2.7°F).				
0°C to +18°C and +28°C to +50°C	±(2% of reading ± 2.0°C) or ±(2% of reading ± 3.6°F).				

Table 1-1 (cont)

Characteristics	Performance Requirements	Supplemental Information
MULTIMETER (cont)		
Multimeter Inputs	Isolated from the oscilloscope ground.	
Input Impedance		
Resistance (DCV)	10 MΩ ± 0.25%.	
Capacitance (AC RMSV)	180 pF ± 10%.	
Maximum Safe Input Voltage		In all CTM functions and ranges.
+ (Positive) Input to Ground	500 V (dc + peak ac).	
– (Negative) Input to Ground	500 V (dc + peak ac).	
Positive to Negative Inputs	500 V (dc + peak ac).	
CH 1 Volts	Ranges Resolution	Ranges determined by CH 1 VOLTS/DIV switch. Multimeter automatically switches to 10X ranges when a P6121 is used.
1X Probe	0.5 V 100 μV 5 V 1 mV 50 V 10 mV	
10X Probe (P6121)	5 V 1 mV 50 V 10 mV 500 V 100 mV	
Dc Volts		
Display Update Rate		
Accuracy	1X Probe 10X Probe	
+18°C to +28°C	±(0.30% of reading +6 LSDs)	±(0.50% of reading +6 LSDs)
0°C to +18°C and +28°C to +50°C	±(0.5% of reading +20 LSDs)	±(0.7% of reading +20 LSDs)
Normal Mode Rejection Ratio	≥30 dB from 48 Hz to 62 Hz.	

Table 1-1 (cont)

Characteristics	Performance Requirements		Supplemental Information	
MULTIMETER (cont)				
AC RMS Volts			Selected by setting the Channel 1 input coupling switch to AC RMSV.	
Display Update Rate			≥2.5 per second.	
Accuracy	1X Probe		Probe compensation is adjusted ±0.1% of reading with CH 1 VOLTS VOLTS/DIV switch set to 0.5 (X10) apply 4 V ±0.01%, 20 kHz sinewave.	
	50 Hz to 100 Hz	100 Hz to 20 kHz		P6121 10X Probe
	20 Hz to 20 kHz			
+18°C to +28°C	±(2.0% of reading +6 LSDs)	±(1.0% of reading +6 LSDs)	±(2.0% of reading +6 LSDs)	
0°C to +18°C and +28°C to +50°C	±(2.25% of reading +8 LSDs)	±(1.25% of reading +8 LSDs)	±(2.25% of reading +8 LSDs)	
Crest Factor	≤3.0 to maintain stated accuracy.			
POWER SOURCE				
Line Voltage Ranges	90 V to 250 V.			
Line Frequency	48 Hz to 440 Hz.			
Maximum Power Consumption	60 W (110 VA).			
Line Fuse	1.25 A, 250 V, slow-blow.			
CATHODE-RAY TUBE				
Display Area	80 by 100 mm.			
Standard Phosphor	P31.			
Nominal Accelerating Voltage	14 kV.			

Table 1-2
Environmental Characteristics

Characteristics	Description
	NOTE <i>The instrument meets the requirements of MIL-T-28800C, paragraphs 4.5.5.1.3, 4.5.5.1.4, and 4.5.5.1.2.2 for Type III, Class 5 equipment, except for maximum operating temperature, and minimum storage temperature as indicated.</i>
Temperature	
Operating AC RMSV, DCV, and Ω Modes	0° to 40°C (+32°F to +104°F).
All Other Modes	0° to +50°C (+32° to +122°F).
Nonoperating	–50°C to +75°C (–58°F to +167°F). Tested to MIL-T-28800C paragraphs 4.5.5.1.3 and 4.5.5.1.4, except in 4.5.5.1.3 steps 4 and 5 (0°C operating test) are performed ahead of step 2 (–50°C nonoperating test). Equipment shall remain off upon return to room ambient during step 6. Excessive condensation shall be removed before operating during step 7.
Altitude	
Operating	To 4,500 m (15,000 ft). Maximum operating temperature decreased 1°C per 1,000 ft above 5,000 ft.
Nonoperating	To 15,000 m (50,000 ft).
Humidity (Operating and Nonoperating)	5 cycles (120 hours) referenced to MIL-T-28800C paragraph 4.5.5.1.2.2, for Type III, Class 5 instruments. Nonoperating and operating of 95% –5% to +0% relative humidity. Operating at +30°C and +40°C for AC RMSV, DCV, and Ω Modes only and operating at +30°C and +50°C for all other modes. Nonoperating at +30°C to +60°C.
Vibration (Operating)	15 minutes along each of 3 major axes at a total displacement of 0.015 inch p-p (2.4 g's at 55 Hz) with frequency varied from 10 Hz to 55 Hz to 10 Hz in 1-minute sweeps. Hold for 10 minutes at 55 Hz in each of the 3 major axes. All major resonances must be above 55 Hz.
Shock (Operating and Nonoperating)	30 g's, half-sine, 11-ms duration, 3 shocks per axis each direction, for a total of 18 shocks.
EMI	Meets radiated and conducted emission requirements per VDE 0871 Class B.

Table 1-3
Physical Characteristics

Characteristics	Description
Weight With Power Cord	
With Cover, Probes, and Pouch	7.3 kg (16 lb).
Without Cover, Probes, and Pouch	6.0 kg (13.3 lb).
Domestic Shipping Weight	10.1 kg (22.2 lb).
Height	
With Feet and Handles	137 mm (5.4 in).
Width	
With Handle	360 mm (14.2 in).
Without Handle	328 mm (12.9 in).
Depth	
With Front Cover	446 mm (17.5 in).
Without Front Cover	440 mm (17.3 in).
With Handle Extended	513 mm (20.2 in).

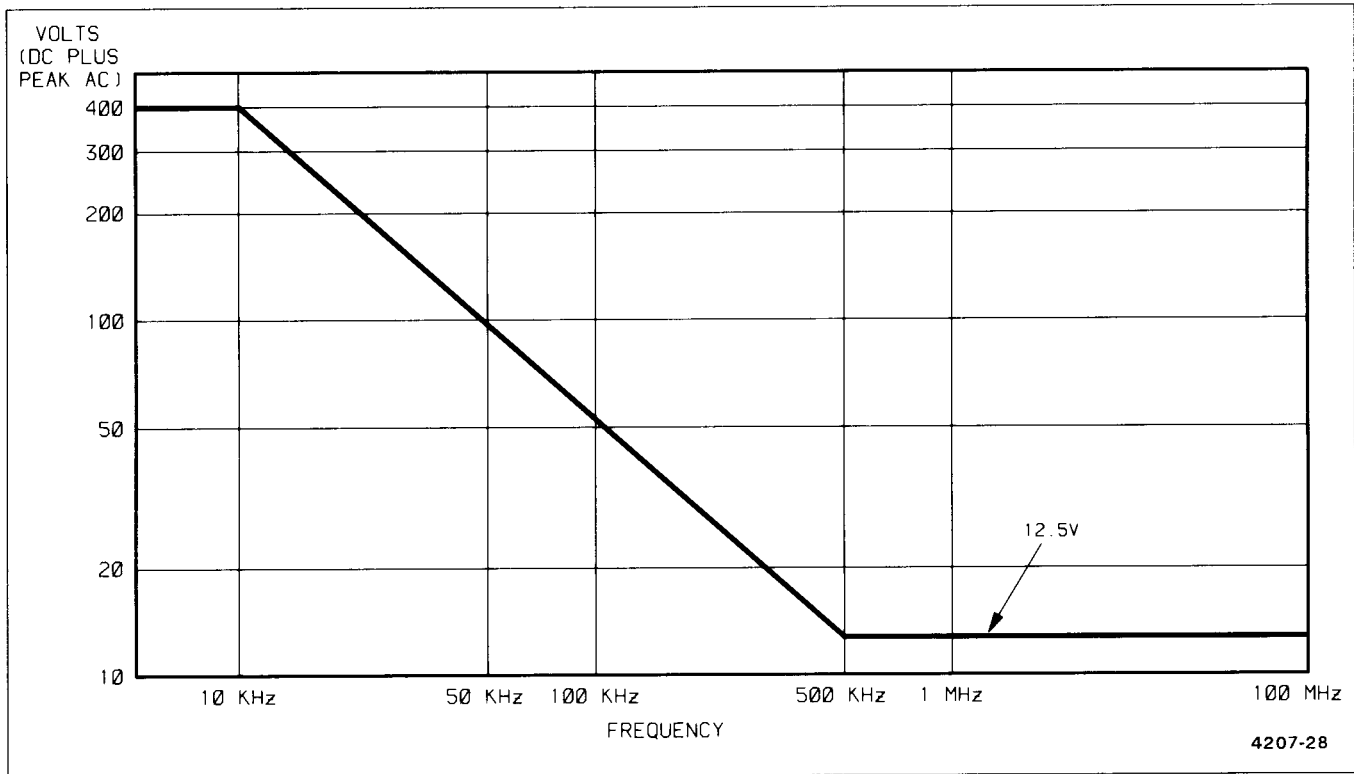
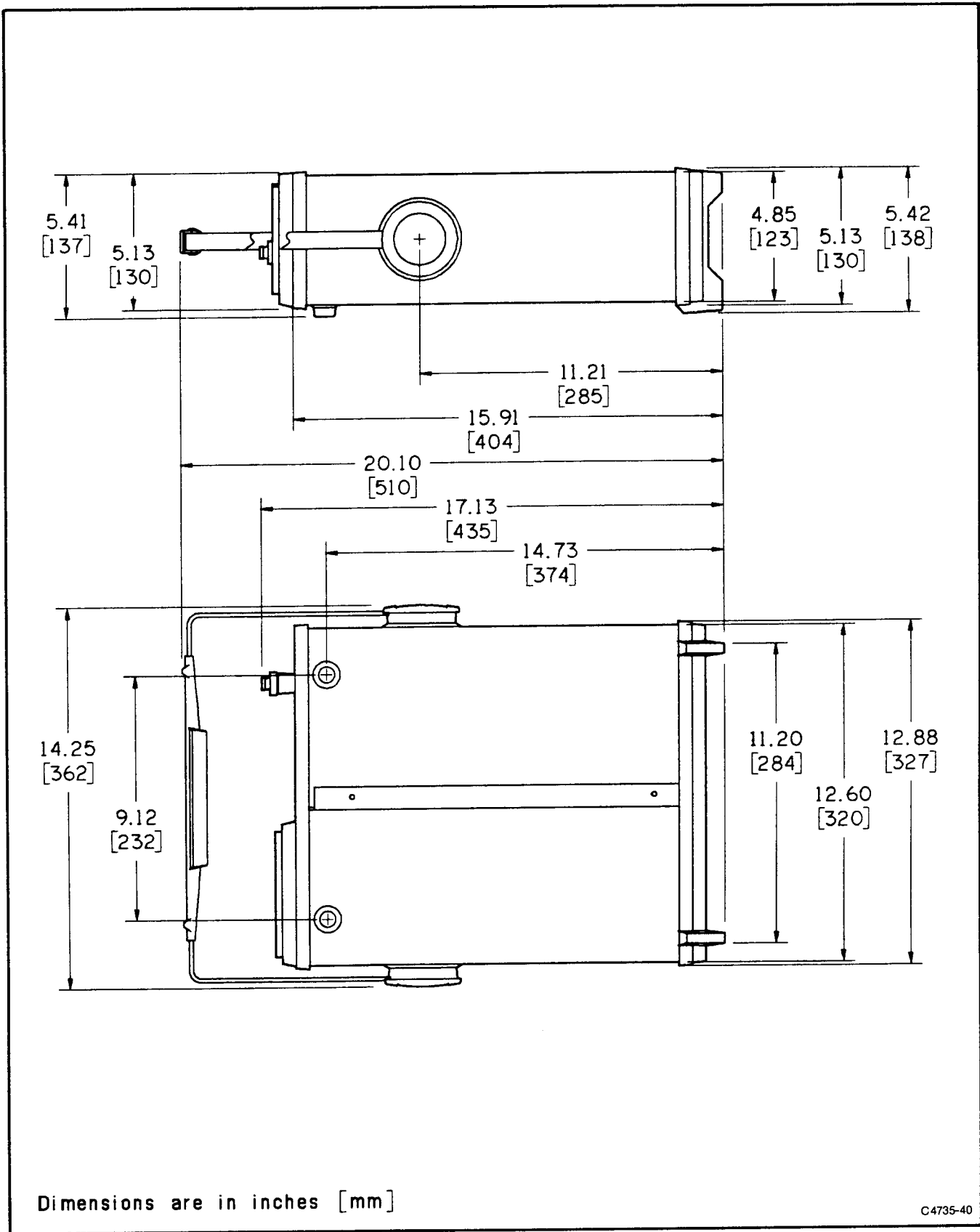


Fig. 1-1. Maximum input voltage vs frequency derating curve for CH 1 OR X & DMM, CH 2 OR Y, and EXT INPUT connectors.



Dimensions are in inches [mm]

C4735-40

Figure 1-2. Physical dimensions of the 2236 Oscilloscope.

CALIBRATION

Instrument performance should be checked after every 2000 hours of operation or once each year if used infrequently. A more frequent interval may be necessary if your instrument is subjected to harsh environments or severe usage.

REPACKAGING FOR SHIPMENT

If the instrument is to be shipped to a Tektronix Service Center for service or repair, attach a tag showing; owner (with address) and the name of an individual at your firm

that can be contacted. Include complete instrument serial number and a description of the service required.

Save and reuse the package in which your instrument was shipped. If the original packaging is unfit for use or not available, repackage the instrument as follows:

Surround the instrument with polyethylene sheeting to protect its finish. Obtain a carton of corrugated cardboard having a carton test strength of 275 pounds and having inside dimensions of no less than six inches more than the instrument dimensions. Cushion the instrument by tightly packing three inches of dunnage or urethane foam between carton and instrument, on all sides. Seal carton with shipping tape or industrial stapler.

PREPARATION FOR USE

FIRST-TIME START UP

SAFETY

Refer to the "Operators Safety Summary" at the front of this manual for power source, grounding, and other safety considerations pertaining to the use of the 2236. Before connecting the instrument to a power source, carefully read the following about line voltages, power cords, and fuses.

LINE VOLTAGE

The instrument is capable of continuous operation using input voltages that range from 90 V to 250 V nominal at frequencies from 48 Hz to 440 Hz.

POWER CORD

A detachable three-wire power cord with a three-contact plug is provided with each instrument to permit connection to both the power source and protective ground. The plug protective-ground contact connects (through the protective-ground conductor) to the accessible metal parts of the instrument. For electrical-shock protection, insert this plug only into a power outlet that has a securely grounded protective-ground contact.

Instruments are shipped with the required power cord as ordered by the customer. Available power-cord options are illustrated in Figure 2-1, and part numbers are listed on the "Accessories" page at the back of this manual. Contact your Tektronix representative or local Tektronix Field Office for additional power-cord information.

LINE FUSE

The instrument fuse holder is located on the rear panel (see Figure 2-2) and contains the line fuse. The following procedure can be used to verify that the proper fuse is installed or to install a replacement fuse.

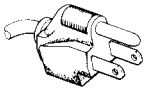
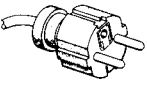
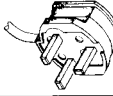


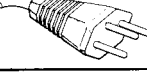
Plug Configuration	Usage	Line Voltage	Reference Standards	Option Number
	North American 120V/ 15A	120V	ANSI C73.11 NEMA 5-15-P IEC 83	Standard
	Universal Euro 240V/ 10-16A	240V	CEE (7),II,IV,VII IEC 83	A1
	UK 240V/ 13A	240V	BS 1363 IEC 83	A2
	Australian 240V/ 10A	240V	AS C112	A3
	North American 240V/ 15A	240V	ANSI C73.20 NEMA 6-15-P IEC 83	A4
	Switzerland 220V/ 6A	220V	SEV	A5
Abbreviations: ANSI — American National Standards Institute AS — Standards Association of Australia BS — British Standards Institution CEE — International Commission on Rules for the Approval of Electrical Equipment IEC — International Electrotechnical Commission NEMA — National Electrical Manufacturer's Association SEV — Schweizerischer Elektrotechnischer Verein				2931-21

Fig. 2-1. Optional Power Cords.

1. Unplug the power cord from the power-input source (if applicable).
2. Press in and slightly rotate the fuse-holder cap counterclockwise to release it.
3. Pull the cap (with the attached fuse inside) out of the fuse holder.

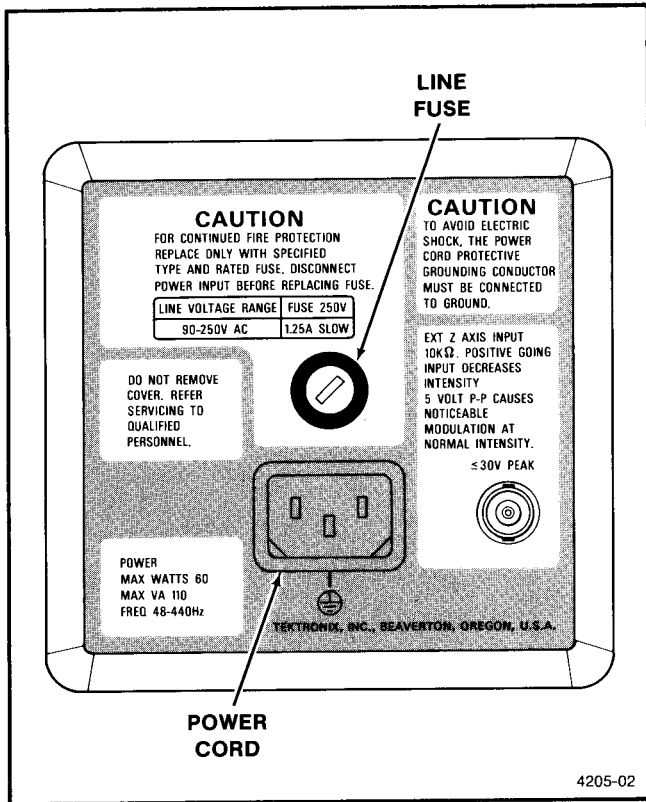


Fig. 2-2. Fuse holder and power cord connector.

4. Verify proper fuse value (see Power Source of Table 1-1 in the "General Information" section).

5. Reinstall the fuse (or replacement fuse) and the fuse-holder cap.

INSTRUMENT COOLING

Always maintain adequate instrument cooling. The ventilation holes on both sides of the equipment cabinet and the fan-exhaust holes in the rear panel must remain free of obstruction.

CONTROLS, CONNECTORS, AND INDICATORS

The following descriptions are intended to familiarize the operator with the location, operation, and function of the instrument's controls, connectors, and indicators.

3 Power Indicator—An LED that illuminates when power is available to the instrument and the POWER switch is set to ON (button in).

4 FOCUS Control—Adjusts for optimum display definition.

DISPLAY, POWER, AND PROBE ADJUST

Refer to Figure 2-3 for location of items 1 through 8.

1 Internal Graticule—Eliminates parallax viewing error between the trace and graticule lines. Rise-time amplitude and measurement points are indicated at the left edge of the graticule.

2 POWER Switch—Turns instrument power on and off. Press in for ON; press again for OFF.

5 PROBE ADJUST Connector—Provides an approximately 0.5-V, negative-going, square-wave voltage (at approximately 1 kHz) that permits an operator to compensate voltage probes and to check operation of the oscilloscope vertical system. It is not intended for verifying the accuracy of the vertical gain or time-base circuitry.

6 BEAM FIND Switch—When held in, compresses the display to within the graticule area and provides a visible viewing intensity to aid in locating off-screen displays.

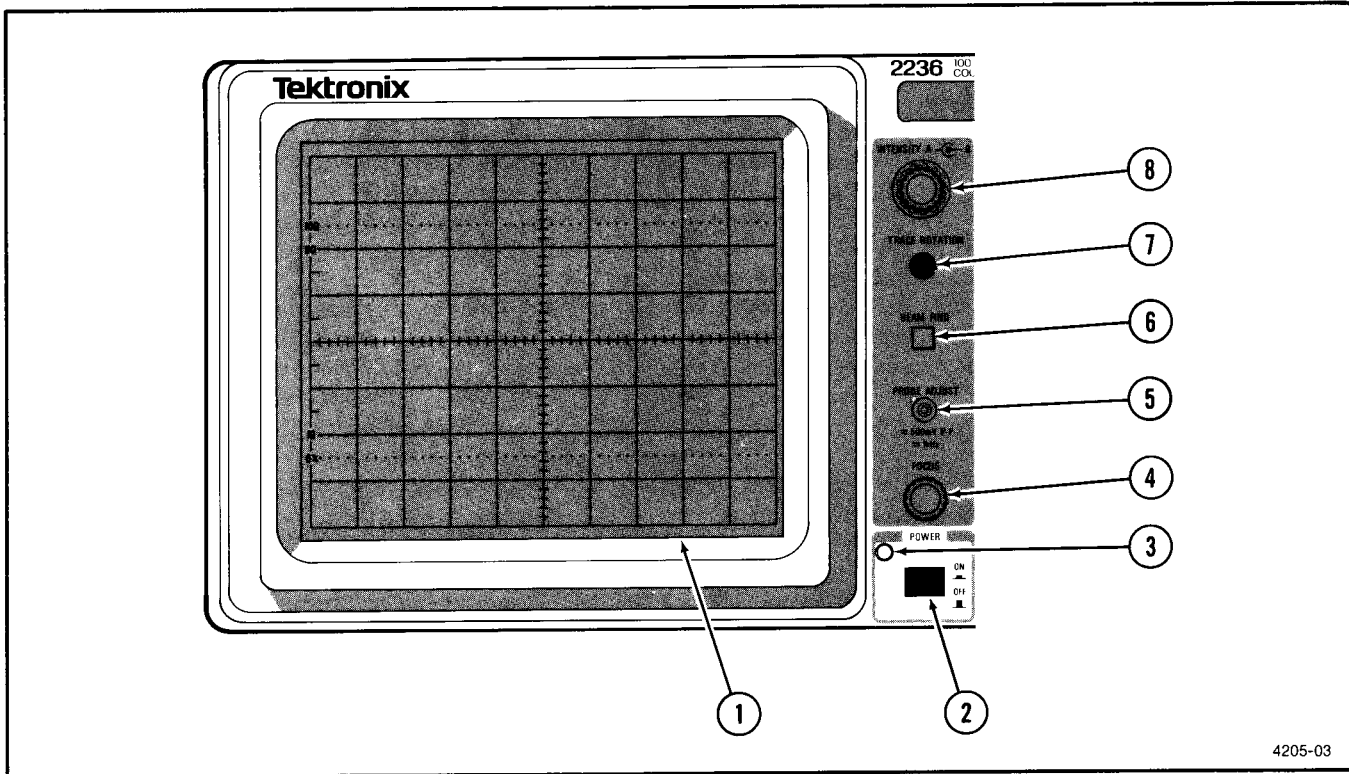


Fig. 2-3. Power and display controls and indicators and PROBE ADJUST output.

- 7 TRACE ROTATION Control—Screwdriver adjustment used to align the crt trace with the horizontal graticule lines.
- 8 A and B INTENSITY Controls—Determine the brightness of the A and B Sweep traces.

VERTICAL

Refer to Figure 2-4 for location of items 9 through 17.

- 9 CH 1 VOLTS/DIV and CH 2 VOLTS/DIV Switches—Used to select the vertical deflection factor in a 1-2-5 sequence. To obtain a calibrated deflection factor, the VOLTS/DIV variable control must be in the calibrated (CAL) detent (fully clockwise). The CH 1 VOLTS/DIV switch selects the range for Multimeter voltage measurements in CH 1 V CTM mode.

1X—Indicates the deflection factor selected when using either a 1X probe or a coaxial cable.

10X PROBE—Indicates the deflection factor selected when using a 10X probe.

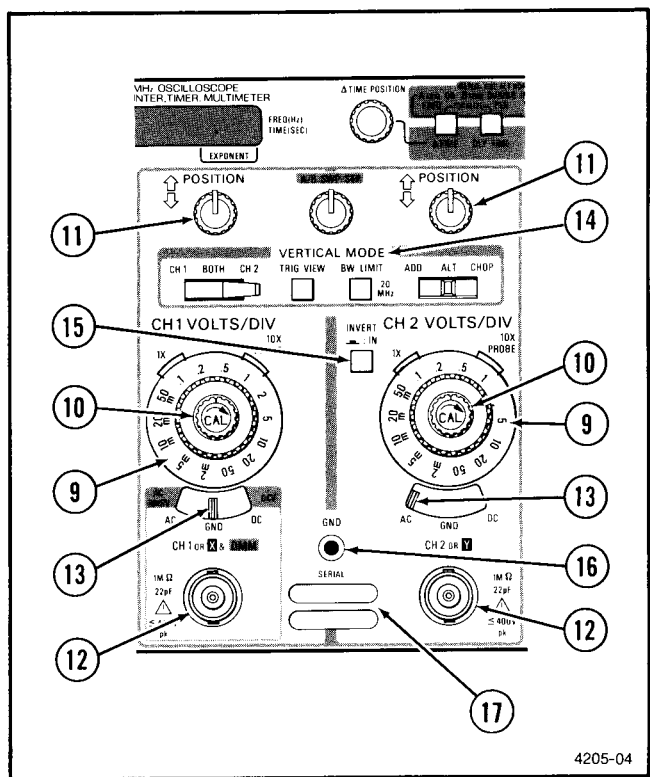


Fig. 2-4. Vertical controls and connectors.

Preparation For Use—2236 Operators

10 VOLTS/DIV Variable Controls—When rotated counterclockwise out of their calibrated detent positions, these controls provide continuously variable, uncalibrated deflection factors between the calibrated settings of the VOLTS/DIV switches. In CH 1 V mode, the CH 1 VOLTS/DIV Variable control has no influence on the Channel 1 volts measurements.

11 POSITION Controls—Used to vertically position the display on the crt. When the SEC/DIV switch is set to X-Y, the Channel 2 POSITION control moves the display vertically (Y-axis), and the Horizontal POSITION control moves the display horizontally (X-axis).

12 CH 1 OR X & DMM and CH 2 OR Y Input Connectors—Provide for application of external signals to the instrument deflection system for display on the crt and to the Multimeter (CH 1 OR X & DMM input connector only. In normal deflection mode (SEC/DIV switch not set to X-Y), signals from both connectors provide vertical deflection on the crt. In the X-Y mode (SEC/DIV switch set to X-Y), the signal connected to the CH 1 OR X input connector provides horizontal deflection (X-axis), and the signal connected to the CH 2 OR Y input connector provides vertical deflection (y-axis).

13 Input Coupling (AC/AC RMSV-GND-DC/DCV and AC-GND-DC) Switches— Three-position switches that select the method of coupling the input signals to the instrument deflection system. When in CH 1 V CTM mode the Channel 1 Input Coupling switch selects the type of voltage measurement the Multimeter will perform on the Channel 1 input signal (AC RMSV or DCV).

AC—Input signal is capacitively coupled to the vertical amplifier. The dc component of the input signal is blocked. Low-frequency limit (-3 dB point) is approximately 10 Hz.

GND—The input of the vertical amplifier is grounded to provide a zero (ground) reference-voltage display (does not ground the input signal). This switch position allows precharging the input coupling capacitor.

DC—All frequency components of the input signal are coupled to the vertical deflection systems.

14 VERTICAL MODE Switches—Two three-position switches and two button switches are used to select the mode of operation for the vertical amplifier system.

CH 1—Selects only the Channel 1 input signal for display.

BOTH—Selects both Channel 1 and Channel 2 input signals for display. The BOTH position must be selected for either ADD, ALT, or CHOP operation.

CH 2—Selects only the Channel 2 input signal for display.

ADD—Displays the algebraic sum of the Channel 1 and Channel 2 input signals.

ALT—Alternately displays Channel 1 and Channel 2 input signals. The alternation occurs during retrace at the end of each sweep. This mode is useful for viewing both input signals at sweep speeds from 0.05 us per division to 0.2 ms per division.

CHOP—The display switches between the Channel 1 and Channel 2 input signals during the sweep. The switching rate is approximately 500 kHz. This mode is useful for viewing both Channel 1 and Channel 2 input signals at sweep speeds from 0.5 ms per division to 0.5 s per division.

TRIG VIEW—Press in and hold this button to display a sample of the signal present in the A Trigger amplifier (for all A SOURCE switch settings). All other signal displays are removed while the TRIG VIEW button is held in.

BW LIMIT—When pressed in, this button switch limits the bandwidth of the vertical amplifier and the A Trigger system to approximately 20 MHz. Button must be pressed a second time to release it and regain full 100-MHz bandwidth operation. Provides a method for reducing interference from high-frequency signals when viewing low-frequency signals.

15 INVERT Switch—Inverts the Channel 2 display when button is pressed in. Button must be pressed in a second time to release it and regain a noninverted display.

16 GND Connector—Provides direct connection to the instrument chassis ground.

17 SERIAL and Mod Slots—The SERIAL slot is imprinted with the instrument's serial number. The Mod slot contains the option number that is installed in the instrument.

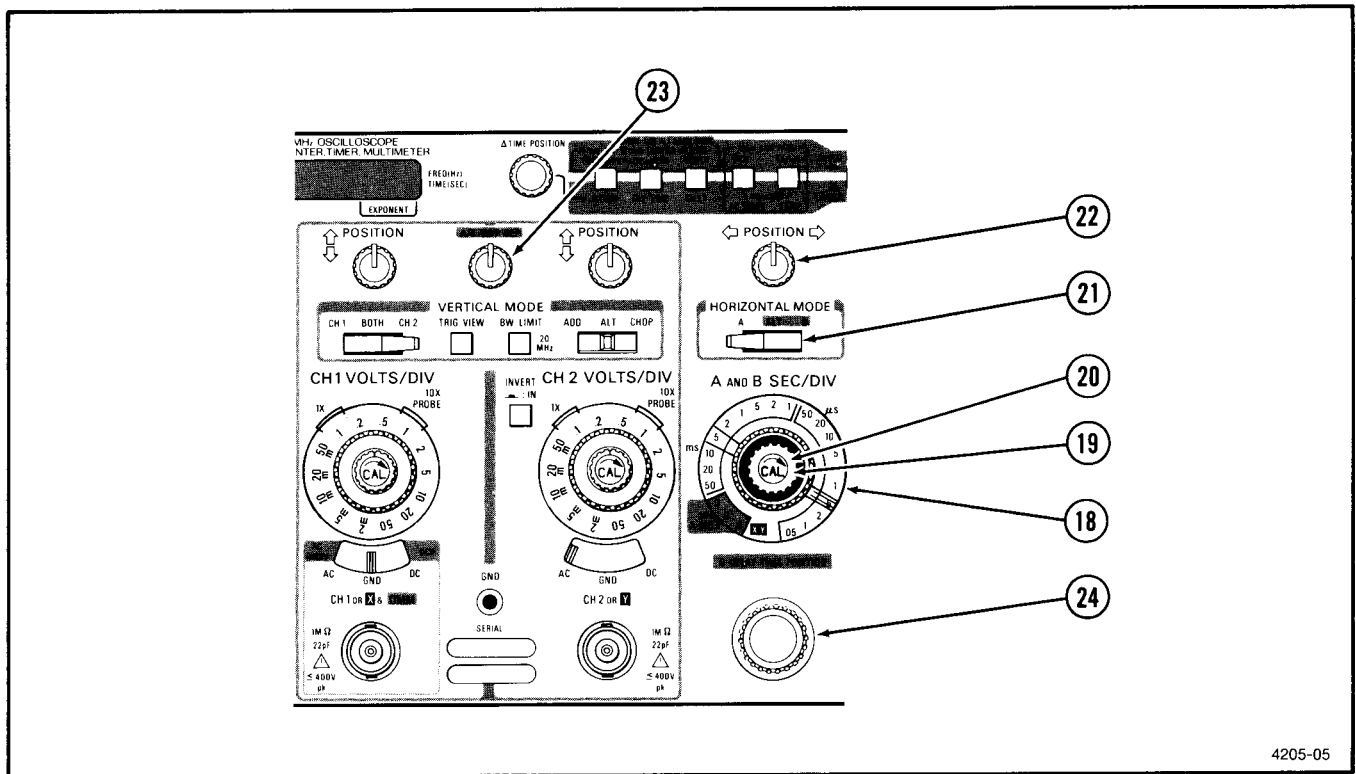


Fig. 2-5. Horizontal controls.

HORIZONTAL

Refer to Figure 2-5 for location of items 18 through 24.

- 18 A and B SEC/DIV Switches—Used to select the sweep speeds for the A and B Sweep generators in a 1-2-5 sequence. To obtain calibrated sweep speeds, the A and B SEC/DIV Variable control must be in the calibrated detent (fully clockwise).

A SEC/DIV—The calibrated sweep speed is shown between the two black lines on the clear plastic skirt. This switch also selects the delay time for delayed-sweep operation when used in conjunction with the B DELAY TIME POSITION control.

B SEC/DIV—The B Sweep speed is set by pulling out the DLY'D SWEEP knob and rotating it clockwise to a setting opposite the white line scribed on the knob. The B Sweep circuit is used only for delayed-sweep operation.

- 19 A and B SEC/DIV Variable Control—Provides continuously variable, uncalibrated A Sweep speeds to at least 2.5 times the calibrated setting. It extends the slowest sweep speed to at least 1.25 s per division.

- 20 X10 Magnifier Switch—To increase displayed sweep speed by a factor of 10, pull out the A and B SEC/DIV Variable knob. The fastest sweep speed can be extended to 5 ns per division. Push in the A and B SEC/DIV Variable knob to regain the X1 sweep speed.

- 21 HORIZONTAL MODE Switch—Three-position switch determines the mode of operation for the horizontal deflection system, and for frequency, period, width, and totalize measurements.

A—Horizontal deflection is provided by the A Sweep generator at a sweep speed determined by the A SEC/DIV switch setting. Nongated frequency, period, width, and totalize measurements are made on the A Trigger signal.

ALT—Alternates the horizontal displays between the A Sweep (with an intensified zone) and the B Delayed Sweep. The A Sweep speed is determined by the setting of the A SEC/DIV switch. The B Sweep speed and the length of the intensified zone on the A Sweep are both determined by the B SEC/DIV switch setting. Gated frequency, period, width, and totalize measurements are made on the B Trigger signal. The gate interval is defined by the length of the intensified zone and is valid only when B Sweep is triggered.

4205-05

Preparation For Use—2236 Operators

B—Horizontal deflection is provided by the B Sweep generator at a sweep speed determined by the B SEC/DIV switch setting. The start of the B Sweep is delayed from the start of the A Sweep by a time determined by the settings of both the A SEC/DIV switch and the B DELAY TIME POSITION control. Gated frequency, period, width, and totalize measurements are made on the B Trigger signal.

- 22 POSITION Control—Horizontally positions both the A Sweep and the B Sweep displays and horizontally positions X-axis in the X-Y mode.
- 23 A/B SWP SEP Control—Vertically positions the B Sweep trace with respect to the A Sweep trace when ALT HORIZONTAL MODE is selected.
- 24 B DELAY TIME POSITION Control—Selects the amount of delay time between the start of the A Sweep and the start of the B Sweep. In Δ TIME mode, the B DELAY TIME POSITION control operates in conjunction with the Δ TIME POSITION control. The B DELAY TIME POSITION control moves both intensified zones (reference and comparisons), while the Δ TIME POSITION control moves only one intensified zone (time-measurement point). Time difference between the start of the two intensified zones is displayed on the readout. In DLY TIME mode, only one intensified zone is displayed which is controlled by the B DELAY TIME POSITION control. The time difference between the start of the A Sweep and the start of the intensified zone is displayed on the readout.

TRIGGER

Refer to Figure 2-6 for location of item 25 through 34.

- 25 A TRIGGER Mode Switches—Three section switch that determines the trigger mode for the A Sweep.

SGL SWP RESET—Press in the spring-return button momentarily to arm the A Sweep circuit or a single-sweep display or to reset the CTM when in TOTALIZE mode. In CH 1 V mode, pressing the SGL SWP RESET button will enter or cancel relative reference mode.

In single-sweep display mode, the trigger system operates the same as NORM, except only one sweep is displayed for each trigger signal. Another sweep cannot be displayed until the SGL SWP RESET button is momentarily pressed in again to reset the A Sweep circuit. This mode is useful for

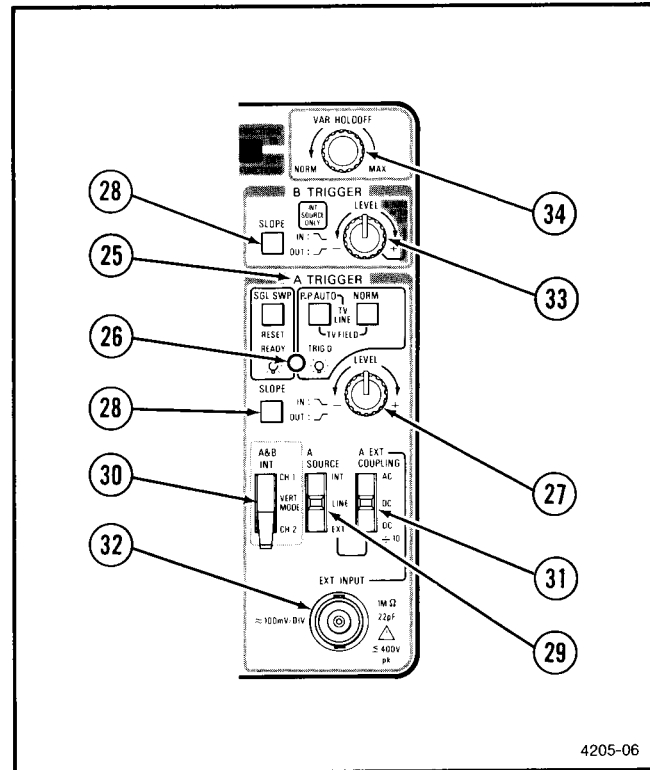


Fig. 2-6. Trigger controls, connector, and indicator.

displaying and photographing either nonrepetitive signals or signals that cause unstable conventional displays (e.g., signals that vary in amplitude, shape, or time). It also allows the gated totalize function to acquire signals over just one gate interval for events counting.

P-P AUTO-TV LINE—Permits triggering on waveforms having repetition rates of at least 20 Hz and television lines. Sweep free-runs in the absence of an adequate trigger signal or when the repetition rate is below 20 Hz. The range of the A TRIGGER LEVEL control is restricted to the peak-to-peak range of the trigger signal.

NORM—Sweep is initiated when an adequate trigger signal is applied. In the absence of a trigger signal, no baseline trace will be present.


TV FIELD—Press in both P-P AUTO and NORM buttons. Permits triggering on television field signals. A TRIGGER LEVEL control range and auto baseline are the same as in P-P AUTO.


- 26 TRIG'D-READY Indicator—LED illuminates when either P-P AUTO or NORM Trigger Mode is selected, when the A Sweep has been triggered (TRIG'D). When SGL SWP RESET button is momentarily

pressed in, the LED illuminates to indicate that the A Trigger circuit is armed (READY) for a single sweep display.

27 A TRIGGER LEVEL Control—Selects the amplitude point on the trigger signal at which the sweep is triggered.

28 SLOPE Switches—Select the slope of the signal that triggers the sweep.

OUT:  —When button is released out, sweep is triggered from the positive-going slope of the trigger signal. In WIDTH mode the CTM measures the positive half cycles of the trigger signals.

IN:  —When button is pressed in, sweep is triggered from the negative-going slope of the trigger signal. In WIDTH mode the CTM measures the negative half cycles of the trigger signals.

29 A SOURCE Switch—Determines the source of the trigger signal that is coupled to the input of the A Trigger circuit.

INT—Permits triggering on signals that are applied to the CH 1 OR X & DMM and CH 2 OR Y input connectors. The source of the internal signal is selected by the A & B INT switch.

LINE—The power-source waveform is the source of the trigger signal. This trigger source is useful when vertical input signals are time related (multiple or submultiple) to the frequency of the power-input source voltage.

EXT—Permits triggering on signals applied to the EXT INPUT connector.

30 A & B INT Switch—Selects the source of the internal triggering signal when the A SOURCE switch is set to INT.

CH 1—The signal applied to the CH 1 OR X & DMM input connector is the source of the trigger signal.

VERT MODE—The internal trigger source is determined by the signals selected for display by the VERTICAL MODE switches. See Table 2-1 for VERT MODE trigger source.

Table 2-1
VERT MODE Trigger Source

VERTICAL MODE	Trigger Source
CH 1	CH 1 OR X & DMM input signal.
CH 2	CH 2 OR Y input signal.
BOTH and ADD	Algebraic sum of CH 1 OR X & DMM and CH 2 OR Y input signals.
BOTH and CHOP	Algebraic sum of CH 1 OR X & DMM and CH 2 OR Y input signals.
BOTH and ALT	Alternates between Channel 1 and Channel 2 on every other sweep (i.e. CH 1 OR X & DMM input signal triggers the sweep that displays Channel 1, and CH 2 OR Y input signal triggers the sweep that displays Channel 2).

CH 2—The signal applied to the CH 2 OR Y input connector is the source of the trigger signal.

31 A EXT COUPLING Switch—Determines the method used to couple external signals to the A TRIGGER circuit from the EXT INPUT connector.

AC—Signals above 60 Hz are capacitively coupled to the input of the A Trigger circuit. Any dc components are blocked, and signals below 60 Hz are attenuated.

DC—All components of the signal are coupled to the input of the A Trigger circuitry. This position is useful for displaying low-frequency or low-repetition-rate signals.

DC ÷ 10—External trigger signals are attenuated by a factor of 10. All components of the signal are coupled to the input of the A Trigger circuit.

32 EXT INPUT Connector—Provides a means of introducing external signals into the A Trigger circuit through the A EXT COUPLING switch.

33 B TRIGGER LEVEL Control—Selects the amplitude point on the trigger signals at which the sweep is triggered. When fully clockwise (B RUNS AFTER DLY), the B Sweep circuit runs immediately following the delay time selected by the A SEC/DIV and the B DELAY TIME POSITION control.

- 34 VAR HOLDOFF Control—Provides continuous control of holdoff time between sweeps. Increases the holdoff time by at least a factor of 10. This control improves the ability to trigger on aperiodic signals (such as complex digital waveforms).

COUNTER, TIMER, AND MULTIMETER

Refer to Figure 2-7 for location of items 35 through 38.

- 35 UPPER FUNCTIONS-LOWER FUNCTIONS Switch—Push-push switch that determines which set of CTM functions is activated by the Function Select switches.
- 36 Function Select Switches—Five button switches along with the UPPER FUNCTIONS-LOWER FUNCTIONS switch select the CTM functions. With all the switch buttons out, the CTM is disabled and the readout is blank.

With the UPPER FUNCTIONS-LOWER FUNCTIONS switch in the IN position the following CTM functions can be selected.

FREQ—Measures the frequency of the trigger signal from the output of the A Trigger circuit (instrument in A HORIZONTAL MODE) or the B Trigger circuit (instrument in ALT or B HORIZONTAL MODE).

PER—Measures the period of the trigger signal from the output of the A Trigger circuit (instrument in A HORIZONTAL MODE) or the B Trigger circuit (instrument in ALT or B HORIZONTAL MODE).

TOTALIZE—Press in both FREQ and PER buttons. Counts trigger events in the A Trigger circuit (instrument in A HORIZONTAL MODE) or the B Trigger circuit (instrument in ALT or B HORIZONTAL MODE). The displayed count can be reset to zero by switching between A and ALT HORIZONTAL MODE or by pressing in momentarily the SGL SWP RESET button.

WIDTH—Measures the width of the trigger signal from the output of the A Trigger circuit (instrument in A HORIZONTAL MODE) or the B Trigger circuit (instrument in ALT or B HORIZONTAL MODE). With the trigger slope switch in positive position, the CTM measures the positive displayed half cycles of the trigger signals; when in negative position the CTM measures the negative displayed half cycles of the trigger signals.

DCV—Measures dc voltage from 0 to 499.9 volts when applied to the Multimeter inputs. The word "OUCH" is displayed if 500 V or more is applied to the Multimeter inputs.

Ω / \rightarrow (Resistance/Semiconductor)—Measures resistance up to 1.99 G [OHMS] or indicates that the device-under-test is a forward-biased semiconductor when applied to the Multimeter inputs.

With the UPPER FUNCTIONS-LOWER FUNCTIONS switch in the OUT position the following CTM functions can be selected.

Δ TIME—Provides two intensified zones on the crt trace for differential time measurements. The location of the first intensified zone is determined by the B DELAY TIME POSITION control, and loca-

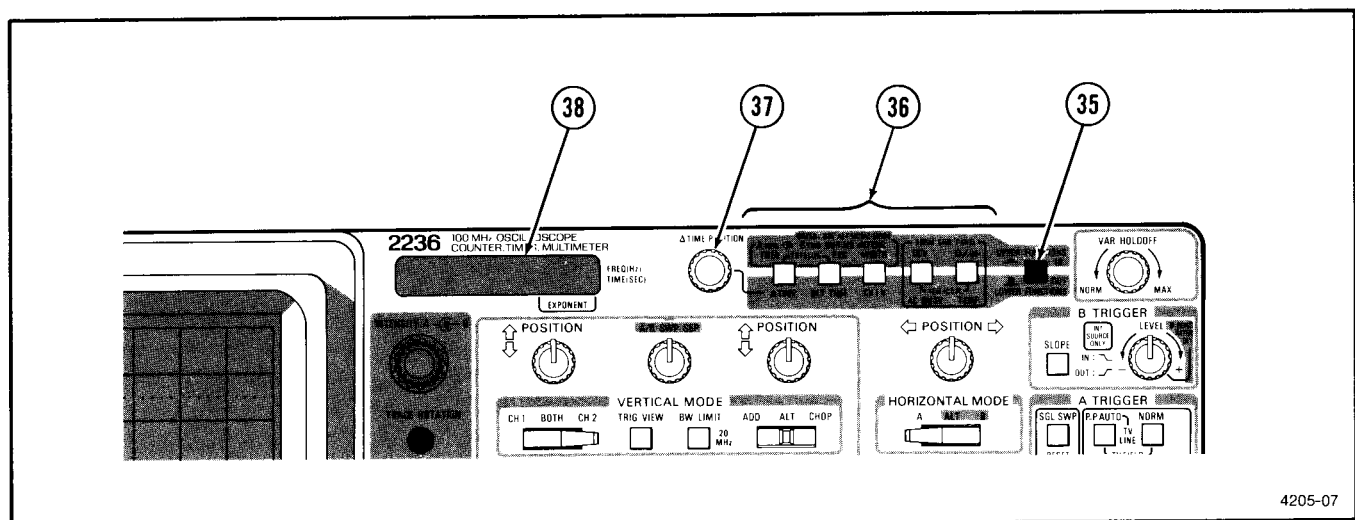


Fig. 2-7. Counter, timer, and multimeter controls and indicators.

tion of the second intensified zone is determined by the Δ TIME POSITION control. The time difference between the start of the two intensified zones is displayed on the readout.

DLY TIME—Measures and displays on the readout the time difference between the start of the B Sweep (B DLY'D SWEEP) and the start of the A Sweep in ALT and B HORIZONTAL MODE.

CH 1 V—Measures dc voltage or true ac rms voltage signals applied to the CH 1 OR X & DMM vertical input connector. For dc voltage measurements set the Channel 1 Input Coupling switch to DCV position, and for true ac rms voltage measurements set the Channel 1 Input Coupling switch to the AC RMSV position. There is no autoranging; CH 1 VOLTS/DIV switch selects the range for the CTM voltage measurements. The readout will indicate the measuring mode the CTM is in by displaying an "Ac" or "dc" on the left side of the voltage reading. In overrange condition the readout will display the word "OUCH".

In CH 1 V mode, the CTM has the capability of storing a relative reference value, such that the displayed value is the input voltage minus the stored reference value. When either Channel 1 AC RMSV or DCV volts are first entered, the stored reference value is zero, and the Channel 1 input voltage is displayed directly. To set the reference value, press in the SGL SWP RESET button momentarily, and the value on the readout becomes the stored reference value. To regain normal voltage measurement press again the SGL SWP RESET button momentarily or change the CH 1 VOLTS/DIV switch position.

AC RMSV—Measures the true ac rms value of the input signal applied to the Multimeter inputs, from 0 V to 349.9 V rms. The word "OUCH" is displayed if 350 V or more is applied to the Multimeter input connector.

TEMP—Measures temperature in degrees Celsius $^{\circ}\text{C}$ when the TEMP button is pressed in, or degrees Fahrenheit $^{\circ}\text{F}$ when both TEMP and Δ TIME buttons are pressed in. Temperature readings following by $^{\circ}\text{C}$ or $^{\circ}\text{F}$ are displayed on the CTM readout.

\llcorner <math>5\Omega (Continuity)—Press in both AC RMSV and TEMP buttons for continuity measurements. For resistance readings below $5.0\ \Omega$ the word "Short" is displayed and an audible tone will be generated. For resistance readings greater than or equal to $5.0\ \Omega$, the word "OPEN" is displayed.

Self Test Routine—The CTM can be entered into a Self Test routine by setting the UPPER FUNC-

TIONS-LOWER FUNCTIONS switch to IN and pressing in the FREQ, PER, and WIDTH buttons at the same time. The message "SELF tEst" will be displayed on the readout to indicate that the routine is in self test mode. To exit from the routine press in any of the CTM front panel buttons to regain normal measurement mode. Repeated pressing of the SGL SWP RESET button will cause the CTM to advance through the test menu. To exit from the test menu, keep pressing the SGL SWP RESET button until "End S-t" message is displayed on the readout. Then exit from the Self Test routine by pressing in any one of the CTM front panel buttons. Self Test routine should normally be performed by a qualified service personnel.

37 Δ TIME POSITION Control—Used in conjunction with the B DELAY TIME POSITION control in Δ TIME mode. The control determines the time difference between the starts of the two intensified zones.

38 Readout—Consists of a nine-digit vacuum fluorescent unit which is used to display measurements selected by the CTM. No polarity indication is displayed for positive values. Negative polarity indication is automatic for negative values. In Counter and Timer modes the decimal point is always placed in one of the three most-significant digits, and the exponent is always an integer multiple of 3. Resistance measurements are also displayed with an exponent. All frequency measurements are in Hertz, and time measurements are in seconds.

RIGHT SIDE PANEL

Refer to Figure 2-8 for location of item 39.

39 Multimeter Connectors—Two banana like jacks provide positive (red) and negative (black) inputs for voltages, resistance, and temperature measurements.

REAR PANEL

Refer to Figure 2-9 for location of item 40.

40 EXT Z-AXIS Connector—Provides a means of connecting external signals to the Z-axis amplifier to intensity modulate the crt. Applied signals do not affect display waveshape. Signals with fast rise times and fall times provide the most abrupt intensity change, and a 5-V p-p signal will produce noticeable modulation. The Z-axis signals must be time-related to the display to obtain a stable presentation on the crt.

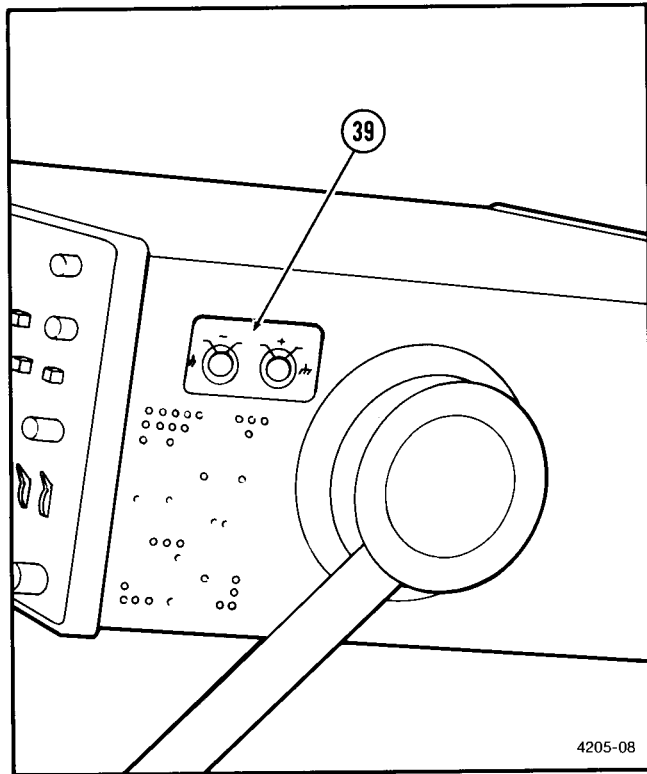


Fig. 2-8. Multimeter right side panel connectors.

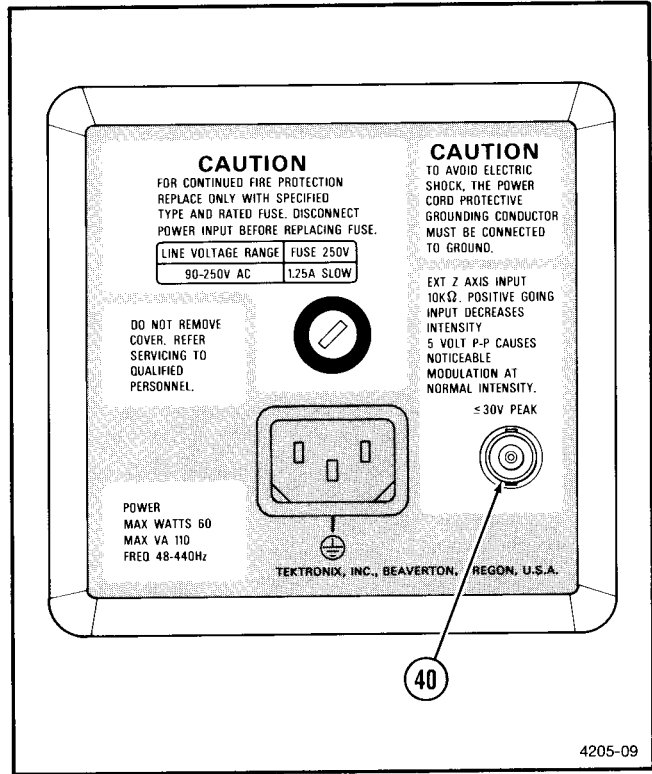


Fig. 2-9. Rear-panel connector.

OPERATORS FAMILIARIZATION

GENERAL OPERATING INFORMATION

GRATICULE

The graticule is internally marked on the faceplate of the crt to enable accurate measurements without parallax error (see Figure 3-1). It is marked with eight vertical and ten horizontal major divisions. Each major division is divided into five subdivisions. The vertical deflection factors and horizontal timing are calibrated to the graticule so that accurate measurements can be made directly from the crt. Also, percentage markers for the measurement of rise and fall times are located on the left side of the graticule.

GROUNDING

The most reliable signal measurements are made when the 2236 and the unit under test are connected by a common reference (ground lead), in addition to the signal lead or probe. The probe's ground lead provides the best grounding method for signal interconnection and ensures the maximum amount of signal-lead shielding in the probe cable. A separate ground lead can also be connected from the unit under test to the oscilloscope GND connector located on the front panel.

For floating Multimeter measurements the —(negative) connector (located on the right side panel) should be connected to the lower impedance point of the unit-under-test being measured, to minimize loading.

SIGNAL CONNECTIONS

Generally, probes offer the most convenient means of connecting an input signal to the instrument. They are shielded to prevent pickup of electromagnetic interference, and the supplied 10X probe offers a high input impedance that minimizes circuit loading. This allows the circuit under test to operate with a minimum of change from its normal condition as measurements are being made.

Coaxial cables may also be used to connect signals to the input connectors, but they may have considerable effect

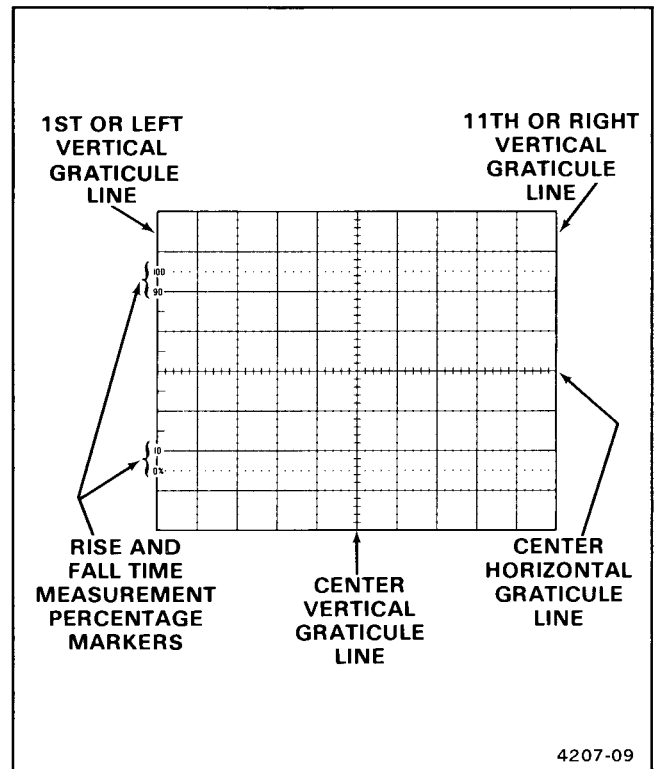


Fig. 3-1. Graticule measurement markings.

on the accuracy of a displayed waveform. To maintain the original frequency characteristics of an applied signal, only high-quality, low-loss coaxial cables should be used. Coaxial cables should be terminated at both ends in their characteristic impedance. If this is not possible, use suitable impedance-matching devices.

INPUT COUPLING CAPACITOR PRECHARGING

When the Input Coupling switch is set to GND, the input signal is connected to ground through the input coupling capacitor in series with a 1-M Ω resistor to form a

precharging network. This network allows the input coupling capacitor to charge to the average dc-voltage level of the signal applied to the probe. Thus any large voltage transients that may accidentally be generated will not be applied to the amplifier input when the Input Coupling switch is moved from GND to AC. The precharging network also provides a measure of protection to the external circuitry by reducing the current levels that can be drawn from the external circuitry during capacitor charging.

The following procedure should be used whenever the probe tip is connected to a signal source having a different dc level than that previously applied, especially if the dc-level difference is more than 10 times the VOLTS/DIV switch setting:

1. Set the Input Coupling switch to GND.

2. Insert the probe tip into the oscilloscope GND connector and wait several seconds for the input coupling capacitor to discharge.

3. Connect the probe tip to the signal source and wait several seconds for the input coupling capacitor to charge.

4. Set the Input Coupling switch to AC. The display will remain on the screen, and the ac component of the signal can be measured in the normal manner.

POWER-UP CHECKS

The Counter, Timer, and Multimeter (CTM) contains Power-Up Checks that are performed each time the instrument is turned on. These checks consists of ROM checksum, counter, and DMM in this order. Each of these checks must pass before proceeding to the next check. If a check fails, an error message will appear in the readout (see Table 3-1). Refer the error message to qualified service personnel.

TABLE 3-1
Power-Up Checks

Check	Error Message
ROM Checksum	FAIL-ro
Counter	FAIL-ctr
DMM	FAIL-d

CTM MEASUREMENT CONSIDERATIONS

Nongated measurements are performed from the A Trigger system on signals selected by the A Trigger source switches. Signals may be applied through the CH 1 input, CH 2, or the EXT INPUT connectors. Nongated measurements may also be performed on the instrument power source by setting the A SOURCE switch to LINE position. The A TRIGGER LEVEL control, A TRIGGER Mode, A TRIGGER SLOPE, A&B INT, A SOURCE, A EXT COUPLING, and BW LIMIT switches are effective in conditioning the input signal.

Trigger status messages (“no A trig” and “no b trig”) are not displayed in any mode of the width function so that measurement results can be displayed indefinitely. This allows single pulse measurements.

Gated measurements are performed from the B Trigger system on input signals being applied to either CH 1, or CH 2 input connectors. The gate interval (set by adjusting the intensified zone with the B DELAY TIME POSITION control and the B SEC/DIV switch) must be shorter than the A Sweep duration, such that the intensified zone ends before A Sweep ends. The A TRIGGER A&B INT switch and the B TRIGGER LEVEL control and SLOPE switch are effective in conditioning the input signal.

Noise may be coupled to the A and B Trigger circuits along with the signal to be measured. Noise may originate from the operating environment, the signal source, or by improper connections. If the noise is of sufficient amplitude, it can result in inaccurate measurements due to false triggering. The 2236 has a 20 MHz Bandwidth Limiter that is helpful in removing or reducing the noise in the A and B Trigger systems.

Channel 1 volts measurements should be made with the signal fully displayed within the graticule area through the appropriate use of the CH 1 VOLTS/DIV switch and CH 1 VOLTS/DIV Variable control. This prevents the Channel 1 input circuit from being overdriven and distorting the voltage measurements.

STATUS AND ERROR MESSAGES

The Counter, Timer, and Multimeter (CTM) system will display several types of status and error messages on the readout.

Control button Error—When the buttons are in an illegal mode, the readout will display “Control button Error” by scrolling it across the readout. The error message will repeat itself until a correction is made.

O'FLO—When measuring the width of an input signal that exceeds five seconds in duration, the overflow message "O'FLO" will be displayed on the readout.

no ALT H—With the instrument in A HORIZONTAL MODE (non-delay), the readout will display a "no ALT H" when either the Δ TIME or DLY TIME mode is selected.

no A trig—With the Δ TIME mode and either the ALT or B HORIZONTAL MODE selected, the readout will display "no A trig" when either the A Sweep is not running, or is too slow. This message is also displayed with the instrument in A HORIZONTAL MODE and either the FREQ or PER mode selected, and the CTM is not receiving a trigger signal.

no b trig—When either the Δ TIME or DLY TIME mode and either ALT or B HORIZONTAL MODE is selected with the A Sweep triggered and the B Trigger circuit not receiving a trigger signal in delay mode, the readout will display "no b trig". This message is also displayed with the instrument in either ALT or B HORIZONTAL MODE and either the FREQ or PER mode selected, and the CTM is not receiving a trigger signal.

OPEN—The readout will display "OPEN" with the CTM in either Ohms or Continuity mode (AC RMSV and TEMP buttons pressed in) under the following conditions; in Ω mode one or both test leads disconnected or when resistance exceeds 1.99 G Ω , in Continuity mode when the resistance equals or exceeds 5.0 Ω .

diode—In Resistance/Semiconductor mode the readout will momentarily display "diode", and an audible tone will be generated if the device being measured is a forward-biased semiconductor junction. After ap-

proximately one second, it will display the forward voltage drop of the device.

Fd—In Ohms mode "Fd" will be displayed on the left side of the readout to indicate that a forward voltage drop is being displayed.

Probe-?—When the temperature probe exceeds its internal resistance limits the readout will display "Probe-?" to indicate that the temperature probe is either faulty or disconnected from the Multimeter input connectors.

Short—In Continuity mode the readout will display "Short" when the measured resistance is less than 5.0 Ω .

OUCH—The word "OUCH" is displayed when the input voltage to the multimeter inputs is 500 volts or more in DCV mode, and 350 volts or more in AC RMSV mode. In CH 1 V mode, the word "OUCH" is displayed if overranged.

dc—In CH 1 V mode with Channel 1 Input Coupling switch in GND or DCV position, "dc" will be displayed on the left side of the readout.

Ac—In CH 1 V mode with Channel 1 Input Coupling switch in AC RMSV position, "Ac" will be displayed on the left side of the readout.

r—In CH 1 V Relative Reference mode, "r" will be displayed on the right side of the readout.

no dELTA—When in Δ TIME mode with the measurement intensified zone (moved by rotating the Δ TIME position control) dialed off the right end of the trace, the readout will display "no dELTA".

OPERATOR'S ADJUSTMENTS

INTRODUCTION

To verify the operation and accuracy of your instrument before making measurements, perform the following adjustment procedures. If adjustments are required beyond the scope of the operators's adjustments, refer the instrument to a qualified service technician.

Before proceeding with these instructions, refer to "Preparation for Use" (Section 2).

Verify that the POWER switch is OFF (push button out), then plug the power cord into the power-source outlet.

If indications specified in these procedures cannot be obtained, refer the instrument to a qualified service technician.

BASELINE TRACE

First obtain a baseline trace, using the following procedure.

1. Preset the instrument front-panel controls as follows:

Display

A and B INTENSITY	Fully counterclockwise
FOCUS	Midrange

Vertical (Both Channels)

POSITION	Midrange
VERTICAL MODE	CH 1
BW LIMIT	Off (button out)
VOLTS/DIV	50 m
VOLTS/DIV Variable	CAL detent
INVERT	Off (button out)
Input Coupling	AC


Horizontal

A/B SWP SEP	Off midrange
POSITION	Midrange
HORIZONTAL MODE	A
A and B SEC/DIV	0.5 ms
SEC/DIV Variable	CAL detent
X10 Magnifier	Off (knob in)
B DELAY TIME POSITION	Fully counterclockwise

B TRIGGER

SLOPE	OUT: 
LEVEL	Fully clockwise

A TRIGGER

VAR HOLDOFF	NORM
Mode	P-P AUTO
SLOPE	OUT: 
LEVEL	Midrange
A&B INT	VERT MODE
A SOURCE	INT
A EXT COUPLING	AC

CTM

Δ TIME POSITION	Midrange
Function Select	All buttons out
UPPER FUNCTIONS-	
LOWER FUNCTIONS	OUT

2. Press in the POWER switch button (ON) and allow the instrument to warm up (20 minutes is recommended for maximum accuracy).

3. Adjust the A INTENSITY control for desired display brightness.

4. Adjust the Vertical and Horizontal POSITION controls as needed to center the trace on the screen.

TRACE ROTATION

Normally, the resulting trace will be parallel to the center horizontal graticule line, and the Trace Rotation adjustment should not be required. If adjustment is needed, perform the following procedure:

1. Preset instrument controls and obtain a baseline trace.
2. Use the Channel 1 POSITION control to move the baseline trace to the center horizontal graticule line.
3. If the resulting trace is not parallel to the center horizontal graticule line, use small flat-bit screwdriver to adjust the TRACE ROTATION control and align the trace with the center horizontal graticule line.

PROBE COMPENSATION

Channel 1 and Channel 2

Misadjustment of probe compensation is one of the source of measurement error. Most attenuator probes are equipped with a compensation adjustment. To ensure optimum measurement accuracy, always compensate the oscilloscope probes before making measurements. Probe compensation is accomplished as follows:

1. Preset instrument controls and obtain a baseline trace.
2. Connect the two 10X probes (supplied with the instrument) to the CH 1 and CH 2 input connectors.
3. Set both VOLTS/DIV switches to 10 m and set both Input Coupling switches to AC.
4. Select CH 2 VERTICAL MODE and insert the tip of the Channel 2 probe into the PROBE ADJUST output jack.
5. Using the approximately 1-kHz PROBE ADJUST square-wave signal as the input, obtain a 5-division display of the signal.
6. Set the A SEC/DIV switch to display several cycles of the PROBE ADJUST signal. use the Channel 2 POSITION control to vertically center the display.
7. Check the waveform presentation for overshoot and rolloff (see Figure 3-2). If necessary, adjust the probe compensation for flat tops on the waveforms. Refer to the instructions supplied with the probe for details of compensation adjustment.
8. Select CH 1 VERTICAL MODE and connect the Channel 1 probe tip to the PROBE ADJUST output jack.
9. Use the Channel 1 POSITION to vertically center the display and repeat step 7 for the Channel 2 probe.

NOTE

Channel 1 ac rms volts measurement accuracy above 1kHz depends directly upon the precision with which the preceding adjustment is performed. An overshoot of 0.2 division (or 4% of a 5-division display) will add approximately 4% to the displayed reading. Compensation related errors can be reduced to 1/2% or less by carefully adjusting the probe compensation to the PROBE ADJUST square-wave signal.

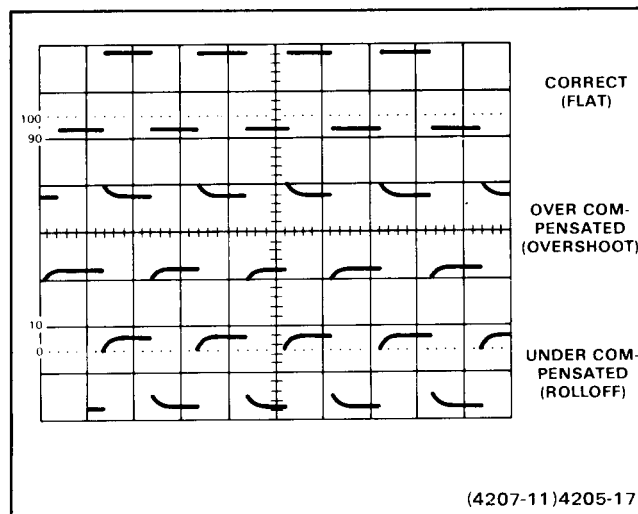


Fig. 3-2. Probe compensation.

Channel 1 AC RMSV

Best measurement accuracy above 1 kHz with a 10X probe can be accomplished by adjusting the probe with the aid of a precision Ac Calibration System. Probe compensation is accomplished as follows:

The equipment listed in Table 3-2, or equivalent equipment, is required to compensate the 10X probe for ac rms volts measurement.

Table 3-2
Equipment Required for 10X Probe Compensation

Description	Minimum Specification
AC Calibration System	Ac voltage: 400 mV to 4 V. Voltage accuracy: 0.01%. Frequency: 10 kHz.
Cable	Impedance: 50 Ω. Length: 42 inch. Connectors: BNC.
Adapter	Connectors: BNC-male-to-miniature probe tip.

1. Preset instrument controls and obtain a baseline trace, set CH 1 VOLTS/DIV switch to 50 mV, and Channel 1 Input Coupling switch to AC RMSV.

2. Connect the AC Calibration System output via a 50-Ω cable to CH 1 OR X & DMM input connector.

Operators Familiarization—2236 Operators

3. Adjust the generator output to produce a 400 mV, 10 kHz display. Vertically center the display.

4. Set UPPER FUNCTIONS-LOWER FUNCTIONS switch to OUT and press in the CH 1 V button.

5. Note the ac voltage display on the readout for future comparison in step 8.

6. Replace the 50- Ω cable with the 10X probe and probe-tip-to BNC adapter.

7. Adjust the generator output signal to 4 volts.

8. Adjust the probe compensation for 10 times the ac voltage display on the readout in step 5.

OPERATING PROCEDURES

BASIC APPLICATIONS

INTRODUCTION

The 2236 Oscilloscope provides an accurate and flexible measurement system. After becoming familiar with the controls, indicators, operating considerations, and capabilities of the instrument, an operator can easily develop their own convenient methods for making particular measurements. The information in this section is designed to enhance operator understanding and to assist in developing efficient techniques for making specific measurements. Recommended methods for making basic measurements with the 2236 are described in the procedures contained in this section.

When a procedure first calls for presetting instrument controls and obtaining a baseline trace, refer to the "Operator's Adjustments" part in Section 3 and perform steps 1 through 4 under "Baseline Trace".

INDEX TO BASIC APPLICATION PROCEDURE

	Page
Voltage Measurements	
AC Peak-to-Peak Voltage	4-1
Instantaneous DC Voltage	4-2
Algebraic Addition	4-3
Common-Mode Rejection	4-3
Amplitude Comparison	4-4
Television Displays	
TV Line Signal	4-4
TV Field Signal	4-5
Delayed-Sweep	
Magnification	4-5
Magnified Sweep Runs After Delay	4-6
Pulse Jitter Time Measurement	4-6
Triggered Magnified Sweep	4-7

Time and Frequency Measurements

Period	4-7
Frequency	4-7
Width	4-7
Time Interval On Signal Waveform	4-8
Rise Time	4-8
Time Difference Between Pulses On Two Time-Related Signals (Short Method)	4-9
Time Difference Between Points On Two Time-Related Signals (General Method)	4-10
Phase Difference	4-11
Gated Measurements	4-11

Multimeter Measurements

Resistance and Semiconductor Junctions	4-12
Continuity	4-13
AC RMS	4-13
DC Volts	4-14
Channel 1 Volts	4-14
Temperature	4-14

VOLTAGE MEASUREMENTS

AC Peak-to-Peak Voltage

To make a peak-to-peak voltage measurement, use the following procedure:

NOTE

This procedure may also be used to make voltage measurements between any two points on the waveform.

1. Preset instrument controls and obtain a baseline trace.
2. Apply the ac signal to either vertical-channel input connector and set the VERTICAL MODE switch to display the channel used.

Operating Procedures—2236 Operators

3. Set the appropriate VOLTS/DIV switch to display about five divisions of the waveform, ensuring that the VOLTS/DIV Variable control is in the CAL detent.

4. Adjust the A TRIGGER LEVEL control to obtain a stable display.

5. Set the A SEC/DIV switch to a position that displays several cycles of the waveform.

6. Vertically position the display so that the negative peak of the waveform coincides with one of the horizontal graticule lines (see Figure 4-1, Point A).

7. Horizontally position the display so that one of the positive peaks coincides with the center vertical graticule line (see Figure 4-1, Point B).

8. Measure the vertical deflection from peak-to-peak (see Figure 4-1, Point A to Point B).

NOTE

If the amplitude measurement is critical or if the trace is thick (as a result of hum or noise on the signal), a more accurate value can be obtained by measuring from the top of a peak to the top of a valley. This will eliminate trace thickness from the measurement.

9. Calculate the peak-to-peak voltage, using the following formula:

$$\text{Volts (p-p)} = \text{vertical deflection (divisions)} \times \text{VOLTS/DIV switch setting indicated by 1X} \times \text{probe attenuation factor}$$

EXAMPLE: The measured peak-to-peak vertical deflection is 4.6 divisions (see Figure 4-1) with a VOLTS/DIV switch setting of 0.5, using a 10X probe.

Substituting the given values:

$$\text{Volts (p-p)} = 4.6 \text{ div} \times 0.5 \text{ V/div} \times 10 = 23 \text{ V.}$$

When using a X10 probe the calculation can be simplified by multiplying the vertical deflection (in divisions) by the VOLTS/DIV switch setting indicated by 10X PROBE.

Substituting the given values:

$$\text{Volts (p-p)} = 4.6 \text{ div} \times 5 \text{ V/div} = 23 \text{ V.}$$

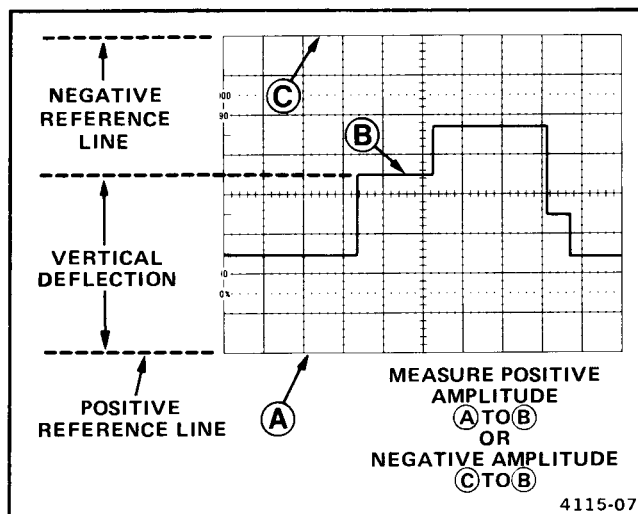


Fig. 4-1. Peak-to-peak waveform voltage.

Instantaneous Voltage

To measure instantaneous level at a given point on a waveform, referred to ground, use the following procedure:

1. Preset instrument controls and obtain a baseline trace.

2. Apply the signal to either vertical-channel input connector and set the VERTICAL MODE switch to display the channel used.

3. Verify that the VOLTS/DIV Variable control is in the CAL detent and set the Coupling switch to GND.

4. Vertically position the baseline trace to the center horizontal graticule line. This establishes the ground reference location.

NOTE

If measurements are to be made relative to a voltage level other than ground, set the Input Coupling switch to DC instead, and apply the reference voltage to the input connector. Then position the trace to the reference (horizontal graticule) line.

5. Set the COUPLING switch to DC. Points on the waveform above the ground reference location are positive. Those points below are negative.

NOTE

If using Channel 2, ensure that the Channel 2 INVERT switch is in its noninverting mode (button out).

6. If necessary, repeat Step 4 using a different reference line which allows the waveform in Step 5 to be displayed on screen.

7. Adjust the A TRIGGER LEVEL control to obtain a stable display.

8. Set the A SEC/DIV switch to a position that displays several cycles of the signal.

9. Measure the divisions of vertical deflection between the ground reference line and the point on the waveform at which the level is to be determined (see Figure 4-2).

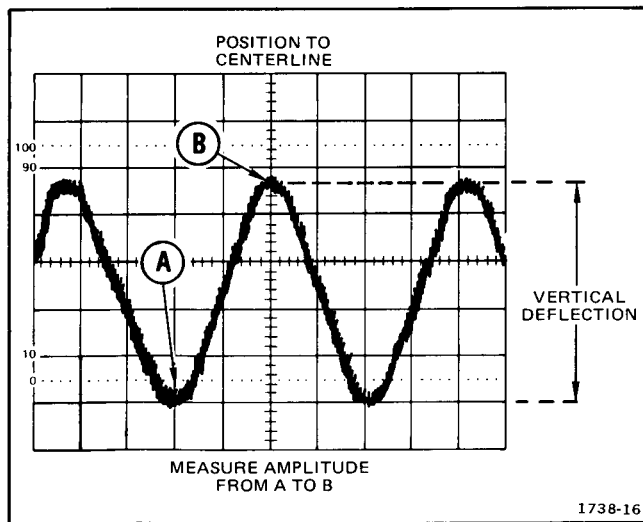


Fig. 4-2. Instantaneous voltage measurement.

10. Calculate the instantaneous voltage, using the following formula:

$$\text{Instantaneous Voltage} = \text{vertical deflection (divisions)} \times \text{polarity (+ or -)} \times \text{VOLTS/DIV switch setting indicated by 1X (or 10X when 10X probe is used)}$$

EXAMPLE: The measured vertical deflection from the reference line is 4.6 divisions (see Figure 4-2), the waveform point is above the reference line, a 10X attenuator probe is being used, and the VOLTS/DIV switch is set to 2.

Substituting the given values:

$$\text{Instantaneous Voltage} = 4.6 \text{ div} \times (+1) \times 2 \text{ V/div} = 9.2 \text{ V.}$$

Algebraic Addition

With the VERTICAL MODE switches set to BOTH and ADD, the waveform displayed is the algebraic sum of the signals applied to the Channel 1 and Channel 2 inputs (CH 1 + CH 2). If the Channel 2 INVERT button is pressed in, the waveform displayed is the difference between the signals applied to the Channel 1 and Channel 2 inputs (CH 1 - CH 2). When both VOLTS/DIV switches are set to the same deflection factor, the deflection factor in the ADD mode is equal to the deflection factor indicated by either VOLTS/DIV switch.

The following general precautions should be observed when using the ADD mode.

- a. Do not exceed the input voltage rating of the oscilloscope.
- b. Do not apply signals that exceed the equivalent of about eight times the VOLTS/DIV switch settings, since large voltages may distort the display. For example, with a VOLTS/DIV switch setting of 0.5, the voltage applied to that channel should not exceed approximately 4 volts.
- c. Use Channel 1 and Channel 2 POSITION control settings which most nearly position the signal on each channel to midscreen, when viewed in either CH 1 or CH 2 VERTICAL MODE. This ensures the greatest dynamic range for ADD mode operation.
- d. To attain similar response from each channel, set both the Channel 1 and Channel 2 Input Coupling switches to the same position.

Common-Mode Rejection

The following procedure shows how to eliminate unwanted ac input-power frequency components. Similar methods could be used either to eliminate other unwanted frequency components or to provide a dc offset.

1. Preset instrument controls and obtain a baseline trace.
2. Apply the signal containing the unwanted line-frequency components to the CH 1 input connector.
3. Apply a line-frequency signal to the CH 2 input connector. To maximize cancellation, the signal applied to Channel 2 must be in phase with the unwanted line-frequency component on the Channel 1 input.

Operating Procedures—2236 Operators

4. Select BOTH and ALT VERTICAL MODE and set both VOLTS/DIV switches to produce displays of approximately four or five divisions in amplitude.

5. Adjust the CH 2 VOLTS/DIV switch and CH 2 VOLTS/DIV Variable control so that the Channel 2 display is approximately the same amplitude as the undesired portion of the Channel 1 display (see Figure 4-3A).

6. Select ADD VERTICAL MODE and press in the INVERT button, and slightly readjust the CH 2 VOLTS/DIV Variable control for maximum cancellation of the undesired signal component (see Figure 4-3B).

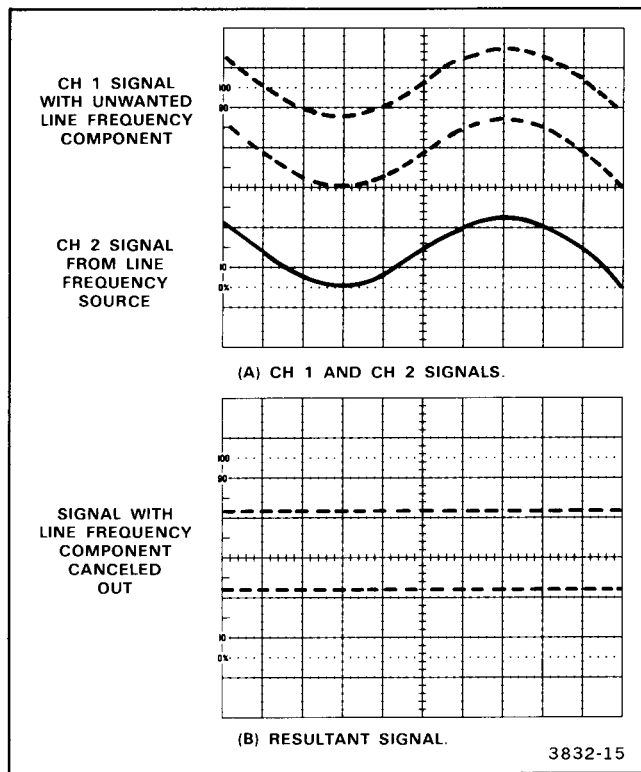


Fig. 4-3. Common-mode rejection.

Amplitude Comparison (Ratio)

In some applications it may be necessary to establish a set of deflection factors other than those indicated by the VOLTS/DIV switch settings. This is useful for comparing unknown signals to a reference signal of known amplitude. To accomplish this, a reference signal of known amplitude is first set to an exact number of vertical divisions by adjusting the VOLTS/DIV switch and Variable control. Unknown signals can then be quickly and accurately compared with the reference signal without disturbing the setting of the VOLTS/DIV Variable control. This procedure is as follows:

1. Preset instrument controls and obtain a baseline trace.

2. Apply the reference signal to either vertical channel input and set the VERTICAL MODE switch to display the channel used.

3. Set the amplitude of the reference signal to five vertical divisions by adjusting the VOLTS/DIV switch and VOLTS/DIV Variable control.

4. Disconnect the reference signal and apply the unknown signal to be measured to the same channel input. Adjust the vertical position of the waveform so that its bottom edge just touches the 0% line on the CRT.

5. Horizontally position the waveform so that its top most features cross the center vertical graticule line (see Figure 4-4).

6. Read the percent ratio directly from the graduations of the center line, referring to the 0% and 100% percentage marks on the left edge of the graticule (1 minor division equals 4% for a 5-division display).

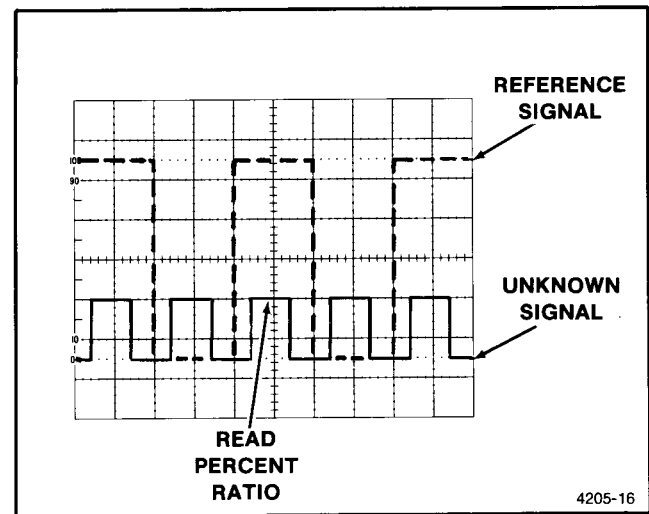


Fig. 4-4. Voltage ratios.

TELEVISION DISPLAYS

TV Line Signal



The following procedure is used to display a TV Line signal.

1. Preset instrument controls and select P-P AUTO/TV LINE A TRIGGER Mode.

2. Apply the TV signal to either vertical-channel input connector and set the VERTICAL MODE switch to display the channel used.

3. Set the appropriate VOLTS/DIV switch to display 0.35 division or more of composite sync signal.

4. Set the A SEC/DIV switch to 10 μ s.

5. Set the A TRIGGER SLOPE switch to either OUT:  (for positive-going TV signal sync pulses) or IN:  (for negative-going TV signal sync pulses).

NOTE

To examine a TV Line signal in more detail, either the X10 Magnifier or the Delayed-Sweep Magnification feature may be used.

TV Field Signal



The television feature of the 2236 can also be used to display TV Field signals.

1. Preset instrument controls and obtain a baseline trace.

2. Select TV FIELD A TRIGGER mode (pushed both P-P AUTO and NORM buttons in) and set the A SEC/DIV switch to 2 ms.

3. To display a signal field, connect the TV signal to either vertical-channel input connector and set the VERTICAL MODE switch to display the channel used.

4. Set the appropriate VOLTS/DIV switch to display 0.35 divisions or more of composite sync signal.

5. Set the A TRIGGER SLOPE switch to either OUT:  (for positive-going TV signal sync pulses) or IN:  (for negative-going TV signal sync pulses).

6. To change the TV field that is displayed, momentarily interrupt the trigger signal by setting the Input Coupling switch to GND and then back to AC until the desired field is displayed.

NOTE

To examine a TV Field signal in more detail, either the X10 Magnifier or the Delayed-Sweep Magnification feature may be used.

7. To display a selected horizontal line, first trigger the sweep on a vertical (field) sync pulse, then use the "Magnified Sweep Runs After Delay" procedure in this part (steps 5 through 7) to magnify the selected horizontal line for a closer examination. This procedure is useful for examining Vertical Interval Test Signals (VITS).

8. To display either Field 1 or Field 2 individually, connect the TV signal to both CH 1 and CH 2 input connectors and select BOTH and ALT VERTICAL MODE.

9. Set in A SEC/DIV switch to a faster sweep speed (displays of less than one full field). This will synchronize Channel 1 display to one field and Channel 2 to the other field.

DELAYED-SWEEP

Magnification

The delayed-sweep feature of the 2236 can be used to provide higher apparent magnification than is provided by the X10 Magnifier switch. Apparent magnification occurs as a result of displaying a selected portion of the A trace at a faster sweep speed (B Sweep speed). The A SEC/DIV switch setting determines how often the B trace will be displayed. Since the B Sweep can occur only once for each A Sweep, the A Sweep time duration sets the amount of time elapse between succeeding B Sweeps.

The intensified zone is an indication of both the location and length of the B Sweep interval within the A Sweep interval. Positioning of the intensified zone (i.e., setting the amount of time between start of the A Sweep and start of the B Sweep) is accomplished with the B DELAY TIME POSITION control. With either ALT or B HORIZONTAL MODE selected and B TRIGGER LEVEL control set fully clockwise (B RUNS AFTER DLY), the B DELAY TIME POSITION control provides continuously variable positioning of the start of the B Sweep. The range of this control is sufficient to place the B Sweep interval at most any location within the A Sweep interval. When ALT HORIZONTAL MODE is selected, the B SEC/DIV switch setting determines the B Sweep speed and concurrently sets the length of the intensified zone on the A trace.

NOTE

Gated FREQ, PER, WIDTH, or TOTALIZE functions alter the length of the intensified zone to indicate the gate interval established by the CTM section, when the B sweep is triggered. Therefore, in these cases the B sweep duration does not match that of the intensified zone.

Using delayed-sweep magnification may produce a display with some slight horizontal movement (pulse jitter). Pulse jitter includes not only the inherent uncertainty of triggering the delayed sweep at exactly the same trigger point each time, but also jitter that may be present in the input signal. If pulse jitter needs to be measured, use the "Pulse Jitter Time Measurement" procedure which follows the discussion of "Magnified Sweep Runs After Delay."

Magnified Sweep Runs After Delay

The following procedure explains how to operate the B Sweep in a nontriggered mode and to determine the resulting apparent magnification factor.

1. Preset instrument controls and obtain a baseline trace.
2. Apply the signal to either vertical channel input connector and set the VERTICAL MODE switch to display the channel used.
3. Set the appropriate VOLTS/DIV switch to produce a display of approximately 2 or 3 divisions in amplitude and center the display.
4. Set the A SEC/DIV switch to a sweep speed which displays at least one complete waveform cycle.
5. Select ALT HORIZONTAL MODE. Adjust both the appropriate channel POSITION control and the A/B SWP SEP control to display the A trace above the B trace.
6. Adjust the B DELAY TIME POSITION control to position the start of the intensified zone to the portion of the display to be magnified (see Figure 4-5).
7. Set the B SEC/DIV switch to a setting which intensifies the full portion of the A trace to be magnified. The intensified zone will be displayed as the B trace (see Figure 4-5). The B HORIZONTAL MODE May also be used to magnify the intensified portion of the A Sweep.
8. The apparent sweep magnification can be calculated from the following formula:

$$\text{Apparent Delayed Sweep Magnification} = \frac{\text{A SEC/DIV switch setting}}{\text{B SEC/DIV switch setting}}$$

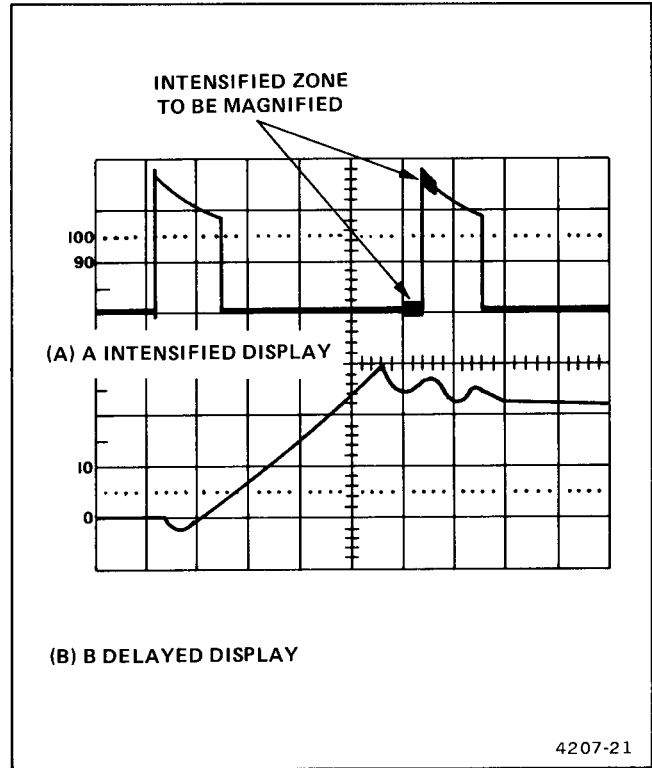


Fig. 4-5. Delayed-sweep magnification.

EXAMPLE: Determine the apparent magnification of a display with an A SEC/DIV switch setting of 0.1 ms and a B SEC/DIV switch setting of 1 us.

Substituting the given values:

$$\text{Apparent Magnification} = \frac{1 \times 10^{-4}\text{s}}{1 \times 10^{-6}\text{s}} = 10^2 = 100$$

Pulse Jitter Time Measurement

To measure pulse jitter time:

1. Perform steps 1 through 7 of the preceding "Magnified Sweep Runs After Delay" procedure.
2. Referring to Figure 4-6, measure the difference between Point C and Point D in divisions and calculate the pulse jitter time using the following formula:

$$\text{Pulse Jitter Time} = \text{Horizontal difference (divisions)} \times \text{B SEC/DIV switch setting}$$

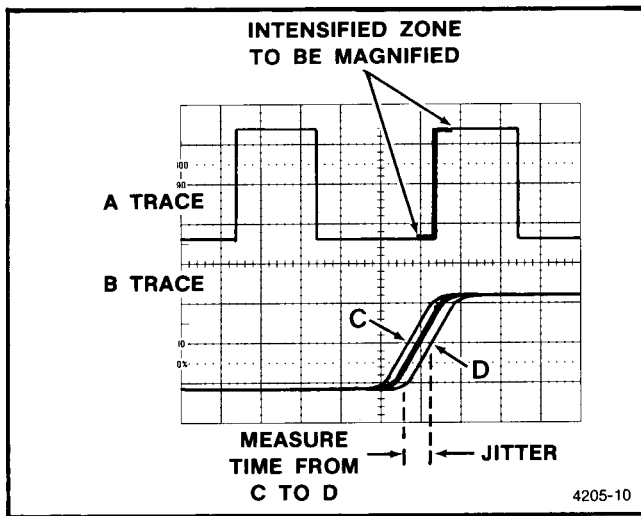


Fig. 4-6. Pulse jitter.

Triggered Magnified Sweep

The following procedure explains how to operate the B Sweep in a triggered mode and to determine the resulting apparent magnification factor. Operating the B Sweep in a triggered mode provides a more stable display, since the delayed display is triggered at the same point each time.

1. Perform steps 1 through 7 of the preceding "Magnified Sweep Runs After Delay" procedure.
2. Adjust the B TRIGGER LEVEL control so the intensified zone on the A trace is stable.

NOTE

The intensified zone seen in the ALT HORIZONTAL MODE display will move from trigger point to trigger point as the B DELAY TIME POSITION control is rotated.

3. The apparent magnification factor can be calculated from the formula shown in step 8 of the "Magnified Sweep Runs After Delay" procedure.

TIME AND FREQUENCY MEASUREMENTS

Period

To measure period between repetitive pulses use the following procedure:

1. Preset instrument controls and obtain a baseline trace.

2. Apply the signal to either vertical-channel input connector and set the VERTICAL MODE switch to display the channel used.

3. Adjust the A TRIGGER LEVEL control to obtain a stable display.

4. Set the A SEC/DIV switch to a position that displays the point of interest within the graticule area.

5. Set UPPER FUNCTIONS-LOWER FUNCTIONS switch to IN and press in the PER button.

6. Read the period between repetitive pulses on the readout.

Frequency

For frequency measurements, use the same method as previously described in "Period" procedure, except that in step 5, the FREQ button is pressed in along with the UPPER FUNCTIONS-LOWER FUNCTIONS switch. The readout will then display the frequency measurement.

Width

When in WIDTH mode, the CTM measures the time interval between a point on the first slope of the selected polarity and the same point on the following slope of the opposite polarity. For waveforms with either slow rise time or fall time, width measurement can be made more accurately by adjusting the A TRIGGER LEVEL control so that the start of the trace is at the 50% point of the waveform. The A Trigger threshold affects the width measurement and should be set carefully.

NOTE



The "no A trig" message is not used in this function, allowing indefinite display of measurement results.

1. Preset instrument controls and obtain a baseline trace.

2. Apply the signal to either vertical-channel input connector and set the VERTICAL MODE switch to display the channel used.

3. Select NORM A TRIGGER mode.

Operating Procedures—2236 Operators

4. Set the A TRIGGER SLOPE switch to OUT:  to measure positive half cycles of the input signal, and to IN:  for measurement of negative half cycles.

5. Adjust the A TRIGGER LEVEL control to trigger on the approximate mid-point on the waveform.

6. Set UPPER FUNCTIONS-LOWER FUNCTIONS switch to IN and press in the WIDTH button.

7. Read the waveform width on the readout.

Time Interval On Single Waveform

The built-in Delta Time function provides tremendous flexibility for making general timing measurements. An internal circuit generates two different delay times alternately which results in two intensified zones on the A Sweep. The Δ TIME POSITION control adjusts the separation of the two intensified zones, and in conjunction with the B DELAY TIME POSITION control, allows the start of each B Sweep to be positioned at any desired waveform location. In B RUNS AFTER DLY mode, the time interval is measured and displayed on the readout. This is a nontriggered delta time measurement.

In triggered delta time measurement mode, the time interval to be measured is defined by similar pulse edges (i.e. positive or negative slopes). The B Sweep is triggered on those edges alternately and the time between the trigger events is measured and displayed on the readout. The intensified zones relocate to correspond with the starts of their respective B Sweeps. Because this mode eliminates oscilloscope delay time jitter from the measurement, displayed results are much more stable.

Use the following procedure to perform both nontriggered and triggered delta time measurements on single waveforms.

1. Preset instrument controls and obtain a baseline trace.

2. Apply the signal to either vertical-channel input connector and set the VERTICAL MODE switch to display the channel used.

3. Set the appropriate VOLTS/DIV switch for a convenient amplitude display of the waveform.

4. Set the A SEC/DIV switch to display the measurement points of interest on the waveform.

5. Select ALT HORIZONTAL MODE and adjust both the appropriate vertical channel POSITION control and A/B SWP SEP control to display the A trace above the B trace.

6. Set UPPER FUNCTIONS-LOWER FUNCTIONS switch to OUT and press in the Δ TIME button.

7. Set the B SEC/DIV switch to the fastest sweep that provides a usable (visible) intensified zone.

8. Adjust the B DELAY TIME POSITION control to move the first (left) intensified zone to cover the starting (reference) point.

9. Adjust the Δ TIME POSITION control to move the second intensified zone to cover the ending (measurement) point.

10. To perform a nontriggered measurement see step 11, and to perform a triggered measurement see step 12.

11. Adjust both B DELAY TIME POSITION and Δ TIME POSITION controls until the points of interest on the two B traces intersect at any convenient vertical graticule line. Read the time interval on the readout.

12. Adjust the B TRIGGER LEVEL control counterclockwise to midrange position to trigger at the desired threshold on the waveform. Read the time interval on the readout.

Rise Time

The following technique describes how to measure rise time between the 10% and 90% points of the low to high transition of the selected waveform using a nontriggered delta time measurement. Fall time is measured between the 90% and 10% points of the high to low transition of the waveform.

1. Preset instrument controls and obtain a baseline trace.

2. Apply the signal to either vertical-channel input connector and set the VERTICAL MODE switch to display the channel used.

3. Set the appropriate VOLTS/DIV switch and variable control for an exact 5-division display.

4. Vertically position the trace so that the zero reference of the waveform touches the 0% graticule line and the top of the waveform touches the 100% graticule line.

5. Set the A SEC/DIV switch to spread out the transition of interest as much as possible.

6. Select ALT HORIZONTAL MODE and set the B SEC/DIV switch to the fastest sweep speed that still allows the intensified zone to overlap the transition of interest.

7. Set UPPER FUNCTIONS-LOWER FUNCTIONS switch to OUT and press in the Δ TIME button.

8. Select B HORIZONTAL MODE and adjust the B INTENSITY control as desired.

9. Set the Δ TIME POSITION control to fully counter-clockwise position.

10. Adjust the B DELAY TIME POSITION control so that the displayed waveform intersects the center vertical graticule line at the 10% point (see Figure 4-7, Point A).

11. Adjust the Δ TIME POSITION control so that as the waveform splits into two, the left most one (corresponding to the longer of the two delay times) intersects the center vertical graticule line at the 90% point (see Figure 4-7, Point B).

12. Read the rise time on the readout.

NOTE

To measure fall time, the procedure is the same except that the right-most transition display is positioned (by the B DELAY TIME POSITION control) so that it intersects the center vertical graticule line at the 90% point. The left-most transition is positioned (by the Δ TIME POSITION control) so that it intersects the center vertical graticule line at the 10% point.

Time Difference Between Pulses On Two Time-Related Signals (Short Method)

Time difference between two time related pulses can often be measured using the triggered delay time technique.

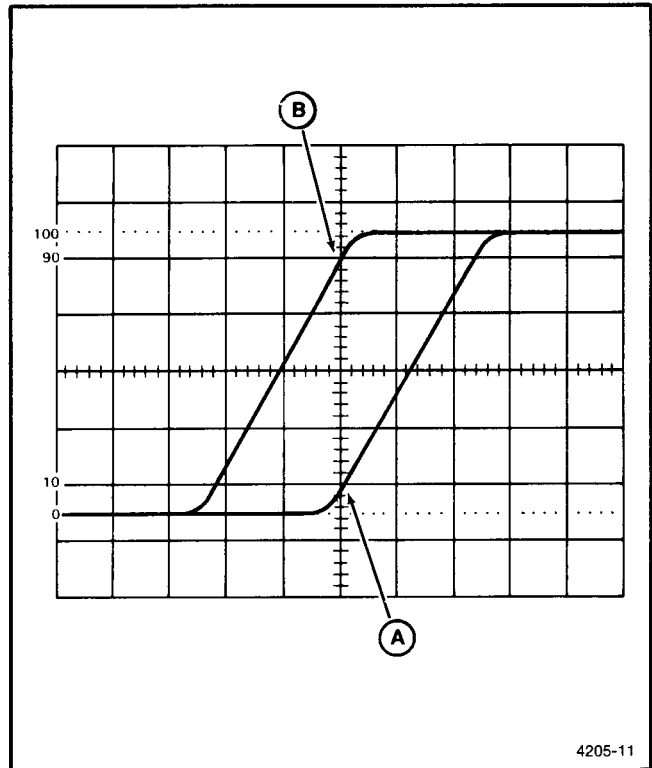


Fig. 4-7. Rise time.

This is accomplished by triggering the A Sweep externally on the reference pulses, and the B Sweep on the pulses whose timing relationship to the reference is to be determined. The measurement is performed from the event triggering the A Sweep to the one triggering the B Sweep. This is possible when the time between the pulses to be measured exceeds 500 ns.

1. Preset controls & obtain baseline trace. Set the A SOURCE switch to EXT, UPPER FUNCTIONS-LOWER FUNCTIONS switch to OUT, and press in the DELAY TIME button.

2. Apply the reference signal to EXT INPUT connector and the comparison signal to CH 1 or CH 2 input connector.

3. Press and hold in the TRIG VIEW button, adjust the A TRIGGER LEVEL to obtain a stable display, triggered on the appropriate edge of the reference signal.

4. Select CH 1 or CH 2 VERTICAL MODE and set the appropriate VOLTS/DIV switch to produce a display of 2 or 3 divisions in amplitude.

5. Select ALT HORIZONTAL mode and set B TRIGGER LEVEL control to fully clockwise position. Position the inten-

Operating Procedures—2236 Operators

sified zone to cover the pulse to be measured and adjust the length of the zone with B TIME/DIV.

6. Select the appropriate B TRIGGER SLOPE, and rotate the B TRIGGER LEVEL control counterclockwise to the midrange position, and trigger on the transition to be measured.

7. Read the time from the reference edge to the edge displayed by the B Sweep on the display.

Time Difference Between Points On Two Time-Related Signals (General Method)

Time difference between pulses on two time-related signals can also be measured in a manner similar to that previously described for measuring time difference between two time related pulses on single waveforms using the delta time measurement procedure.

Increased timing accuracy may be obtained by externally triggering the A Sweep, while internally triggering the B Sweep alternately from Channel 1 and Channel 2 (triggered delta time). The following procedure describes how to measure from a point of interest on the Channel 1 display to a point of interest on the Channel 2 display, with or without the benefit of triggered delta time.

1. Preset instrument controls and obtain a baseline trace. For nontriggered mode, set the A&B INT switch to CH 1, and for triggered mode set A&B INT switch to VERT MODE and the A SOURCE switch to EXT.

2. Using probes or cables having equal time delays, apply the reference signal to the CH 1 input connector and apply the comparison signal to the CH 2 input connector. For triggered measurement, the signal to EXT INPUT connector must also be applied to the CH 1 input connector.

3. Adjust the A TRIGGER LEVEL control to obtain a stable display.

4. Select BOTH and ALT VERTICAL MODE, and set both VOLTS/DIV switches to produce a display of either 2 or 3 divisions in amplitude.

5. Select ALT HORIZONTAL MODE. The first intensified zone (reference) will appear on the Channel 1 trace and the second intensified zone (comparison) will appear on the Channel 2 trace.

6. Adjust Channel 1 POSITION, Channel 2 POSITION, and A/B SWP SEP controls to display the A traces above the B traces.

7. Set the A SEC/DIV switch to display the measurement points of interest within the graticule area.

8. Set UPPER FUNCTIONS-LOWER FUNCTIONS switch to OUT and press in the Δ TIME button.

9. For the most accurate measurement, set the B SEC/DIV switch to the fastest sweep speed that provides a useable (visible) intensified zone.

10. Adjust the B DELAY TIME POSITION control to move the reference zone to the reference signal on the CH 1 A trace (see Figure 4-8).

11. Adjust the Δ TIME POSITION control to move the comparison zone to the comparison signal on the CH 2 A trace (see Figure 4-8).

12. To perform a nontriggered measurement see step 13, and to perform a triggered measurement see step 14.

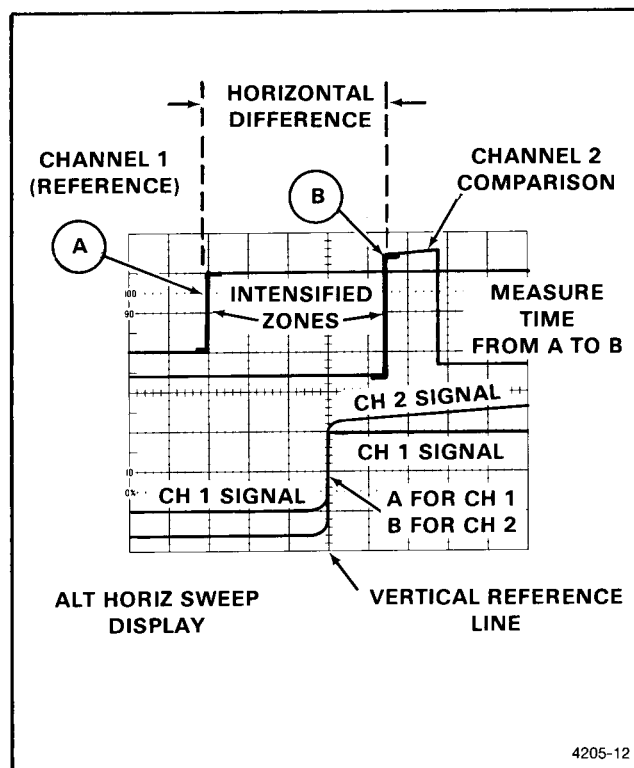


Fig. 4-8. Time difference between points on two time-related signals in nontriggered mode.

13. Adjust both B DELAY TIME POSITION and Δ TIME POSITION controls until the points of interest on the two B traces intersect at any convenient vertical graticule line. Read the time difference on the readout.

14. Adjust the B TRIGGER LEVEL control counterclockwise to midrange position to trigger at the desired threshold of the waveform. Read the time difference on the readout.

Phase Difference

The phase difference between two signals of equal frequency is determined in a manner similar to that described in the preceding procedure for measuring time difference between two time-related pulses. To measure the phase difference between two time-related signals, use the following procedure:

1. Perform steps 1 through 14 of the preceding "Time Difference Between Two Time-Related Pulses" procedure.

2. Record the time difference on the readout.

3. Set the A&B INT switch to CH 1 and A SOURCE switch to INT.

4. Select A HORIZONTAL MODE and set UPPER FUNCTIONS-LOWER FUNCTIONS switch to IN and press in the PER button.

5. Read the period of the two signals on the readout, and calculate the phase difference using the following formula:

$$\text{Phase Difference} = 360 \times \frac{\text{time difference}}{\text{period}}$$

Gated Measurements

Gated measurements of frequency, period, width, and totalize are performed through the B Trigger circuitry. When the B Sweep is properly triggered, the intensified zone duration indicates the gate interval over which the CTM samples the displayed waveform, rather than the duration of B Sweep. The intensified zone blinks at the measurement cycle rate (except when in totalize mode) to indicate that the B Sweep is triggered, and that the CTM is receiving the B Trigger signal.

In gated frequency and period mode, the intensified zone will completely cover one period of the input signal (two consecutive trigger edges) if the B Sweep duration is less than that period. The CTM extends the intensified zone to cover this interval when the B Sweep is triggered. If the B Sweep duration is actually longer than one period of the input sig-

nal, all consecutive periods that fall within the B Sweep duration will be included in the gated measurement. In frequency mode the CTM will display the reciprocal of the average of all periods within the blinking intensified zone. In period mode the CTM will display the arithmetic average of all periods within the blinking intensified zone.

In gated width mode, the intensified zone will cover one pulse width on the input signal, if the B Sweep duration is less than that width. If the B Sweep duration covers more than one pulse width, then the CTM will display the arithmetic average of all the pulse widths inside the blinking intensified zone. Gated width does not display the "no b trig" status message.

The accuracy in gated frequency, period, and width measurements improves as the number of samples within the gate interval increases. It is advantageous to lengthen the intensified zone to include as many trigger events as possible within the gating interval.

In gated totalize mode, one event is counted for each period of input signal inside the intensified zone (the stop trigger edge is not counted).

The following procedure describes how gated measurements are accomplished.

1. Preset instrument controls and obtain a baseline trace.

2. Apply the signal to either vertical-channel input connector and set the VERTICAL MODE switch to display the channel used.

3. Adjust the A TRIGGER LEVEL control to obtain a stable display.

4. Set the A SEC/DIV switch to a position that displays the point of interest within the graticule area.

5. Select ALT HORIZONTAL MODE, set B TRIGGER LEVEL control to fully clockwise position and adjust both the appropriate vertical channel POSITION control and A/B SWP SEP control to display the A trace above the B trace.

6. Set the B SEC/DIV switch to the desired sweep speed and adjust the B DELAY TIME POSITION control to move the intensified zone to that portion of the display to be measured.

7. To select the desired gated measurement function (frequency, period, width, or totalize), set UPPER FUNCTIONS-LOWER FUNCTIONS switch to IN, and press in either FREQ, PER, WIDTH, or TOTALIZE (FREQ and PER) buttons

8. Rotate the B TRIGGER LEVEL control counterclockwise to the midrange position, then adjust the control for a stable display.

9. Observe that the intensified zone moves, covering exactly the interval that the CTM is sampling.

10. Read the measurement on the readout.

2. Connect the multimeter leads across the unknown resistance or across the semiconductor as indicated in Table 4-1. The diode detection circuitry will be activated only when the readout displays the message "OPEN" before the multimeter leads are connected across the device under test.

3. Read the resistance value or the forward voltage drop of the device on the readout.

Determining Semiconductor Leakage Current

The Multimeter performs resistance measurements with a voltage divider technique. A reference voltage of approximately +2.5 volts is applied through an internal precision resistor (reference resistance) to the Multimeter + (positive) connector (see Figure 4-9).

The unknown resistance is calculated from the following formula.

$$\text{Unknown Resistance} = \frac{\text{reference resistance} \times V_{\text{terminal}}}{+2.5 \text{ volts} - V_{\text{terminal}}}$$

A Typical semiconductor will have a reverse leakage current-vs- reverse voltage drop as shown in Figure 4-10). Observe that the typical semiconductor leakage current is relatively constant as the reverse voltage drop increases.

To measure the reverse-leakage current, perform a normal resistance measurement with the Multimeter + (positive) connector connected to the cathode of the device (reverse biased).

MULTIMETER MEASUREMENTS

Resistance and Semiconductor Junctions

Before making resistance measurements ensure that the readout displays the message "OPEN". If the device under test is a linear resistance the CTM will display that resistance on the readout. If the resistance is a nonlinear device (semiconductor) the CTM will automatically enter into the junction test mode and display the message "diodE" on the readout and at the same time generate an audible tone. After a brief moment the CTM will display the forward voltage drop of the semiconductor on the readout. The red lead sources the measuring voltage (+2.5 V in series with 1 kΩ). To measure resistance or forward voltage drop of a semiconductor use, the following procedure:

1. Set UPPER FUNCTIONS-LOWER FUNCTIONS switch to IN and press in the Ω button.

**Table 4-1
Multimeter Connections to
Forward Bias Semiconductors**

Semiconductor	Red Lead	Black Lead	Typical Forward Drop (volts)
Silicon Diode	Anode	Cathode	0.65 V
Silicon NPN Transistor	Base	Collector or Emitter	0.70 V
Silicon PNP Transistor	Collector or Emitter	Base	0.70 V
N Channel Fet	Gate	Drain or Source	0.80 V
LED	Anode	Cathode	1.5 to 2.0 V

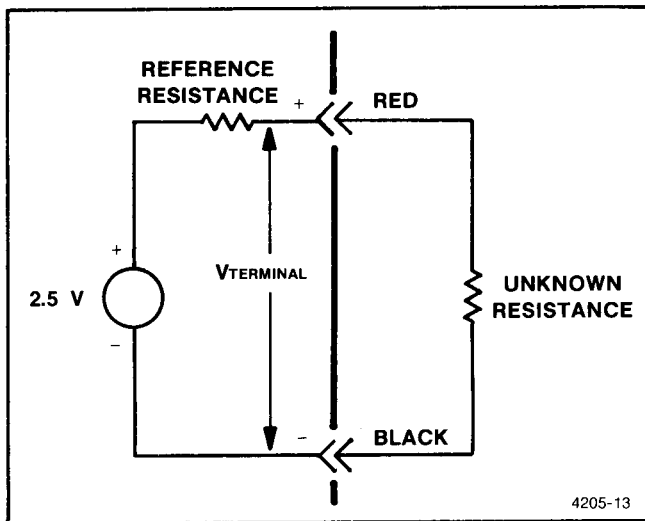


Fig. 4-9. Resistance measurement technique.

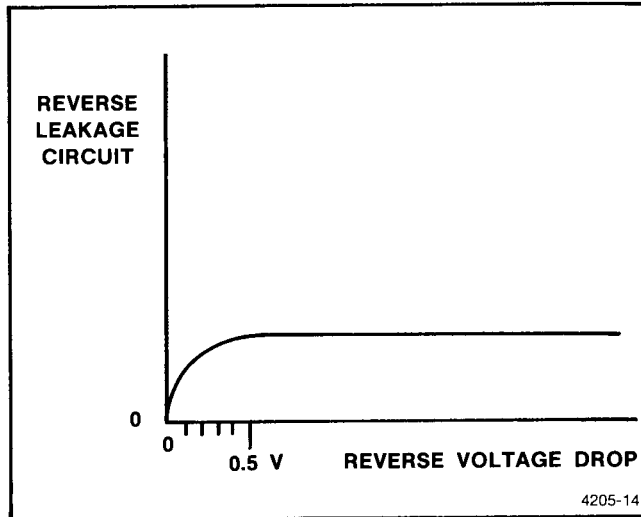


Fig. 4-10. Reverse voltage drop to reverse leakage current characteristics for typical semiconductor.

Calculate the reverse-leakage, using the following formula:

$$\text{Reverse-Leakage Current} = \frac{\text{reference voltage (+2.5 Volts)}}{\text{reference resistance (see Table 4-2)} + \text{resistance displayed on the readout}}$$

Table 4-2
Reference Resistance Values

Resistance Displayed On Readout	Reference Resistance
0 to 50 Ω	1 kΩ
50 Ω to 500 Ω	1 kΩ
500 Ω to 5 kΩ	10 kΩ
5 kΩ to 50 kΩ	100 kΩ
50 kΩ to 500 kΩ	1 MΩ
Greater than 500 kΩ	10 MΩ

Continuity

Continuity checks are made by connecting the test leads across the device under test and measuring the unknown resistance. If the resistance is greater than or equal to 5 Ω the readout will display the message "OPEN"; if the resistance is less than 5 Ω an audible tone is generated and the readout will display the message "Short".

1. Set UPPER FUNCTIONS-LOWER FUNCTIONS switch to OUT and press in both AC RMSV and TEMP buttons.
2. Connect the test leads across the device under test.
3. Listen for audible tone and read the message on the readout.

AC RMS



If the readout displays the message "OUCH" (input voltage equals or exceeds 350 V), immediately disconnect the test leads from the unit-under-test to prevent possible instrument damage.

1. Set UPPER FUNCTIONS-LOWER FUNCTIONS switch to OUT and press in the AC RMSV button.
2. Connect the –(negative) lead to the reference point (usually a ground or test point) and connect the + (positive) lead to the unknown voltage to be measured.
3. Read the rms value of the input signal on the readout.

DC Volts



If the readout displays the message "OUCH" (input voltage equals or exceeds 500 V), immediately disconnect the test leads from the unit-under-test to prevent possible instrument damage.

1. Set UPPER FUNCTIONS-LOWER FUNCTIONS switch to IN and press in the DCV button.

2. Connect the –(negative) lead to the reference point (usually a ground or test point) and connect the + (positive) lead to the unknown voltage to be measured.

3. Read the dc voltage on the readout.

Channel 1 Volts

The 2236 has the capability to measure the dc and true ac coupled rms values of the input signal through CH 1 OR X & DMM connector. Maximum voltage measurement when using either a 1X probe or cable is 49.99 V (dc or ac rms). Maximum voltage measurement with a 10X probe is 499.9 V dc and 349.9 V rms ac. When an overrange condition exists the readout will display the message "OUCH". The procedure for measuring voltage through the CH 1 OR X & DMM input connector is as follows:

1. Preset instrument controls and obtain a baseline trace.

2. Connect either a probe (1X or 10X) or a cable to CH 1 OR X & DMM input connector.

3. Set the Channel 1 Input Coupling switch to either AC RMSV position for ac rms voltage measurement or to DCV position for dc voltage measurement.

4. Set UPPER FUNCTIONS-LOWER FUNCTIONS switch to OUT and press in the CH1V button.

5. Connect the probe ground clip to a reference point (usually a ground or test point) and connect the probe tip to the unknown voltage to be measured.

6. Observe the readout. If necessary, select the next lower CH 1 VOLTS/DIV position to obtain maximum resolution without overranging.

NOTE

CH1 AC RMS voltage measurements are influenced above 1 KHz by probe compensation when a X10 probe is used. See "Probe Compensation" in Section 3 to ensure best results. Below 100 Hz the CH 1 AC coupling time constant degrades direct measurements. Use of a 10X probe increases this time constant and extends the useful range to 20 Hz. CH 1 dc voltage measurements are made without the benefit of a two-pole low pass input filter. Dc voltage measurements made thru the side inputs utilize such a filter and therefore offer better normal mode rejection (rejection of input signal noise).

Temperature

1. Connect the P6602 temperature probe to the Multimeter input connector.

2. Set UPPER FUNCTIONS-LOWER FUNCTIONS switch to OUT.

3. Press in the TEMP button for temperature measurement in Celsius or press both the TEMP and Δ TIME buttons for temperature measurement in Fahrenheit.

4. Read the temperature on the readout.

OPTIONS AND ACCESSORIES

INTRODUCTION

This section contains a general description of instrument options available at the time of publication of this manual. Also included is a complete list (with Tektronix part number) of standard accessories included with each instrument and a partial list of optional accessories. Additional information about instrument options, option availability, and other accessories can be obtained either by consulting the current Tektronix Product Catalog or by contacting your Tektronix Field Office or representative.

OPTION 14

Option 14 replaces the internal 10 MHz time base (clock) circuit with a self-contained temperature compensated crystal oscillator for increased accuracy and stability.

POWER CORD OPTIONS

Instruments are shipped with the detachable power-cord configuration ordered by the customer. Descriptive information about the international power-cord options is provided in Section 2, "Preparation for Use". The following list identifies the Tektronix part numbers for the available power cords.

Description	Part Number
Option A1, 2.5 Meter length	161-0104-06
Option A2, 2.5 Meter length	161-0104-07
Option A3, 2.5 Meter length	161-0104-05
Option A4, 2.5 Meter length	161-0104-08
Option A5, 2.5 Meter length	161-0167-00

STANDARD ACCESSORIES

The following standard accessories are provided with each instrument.

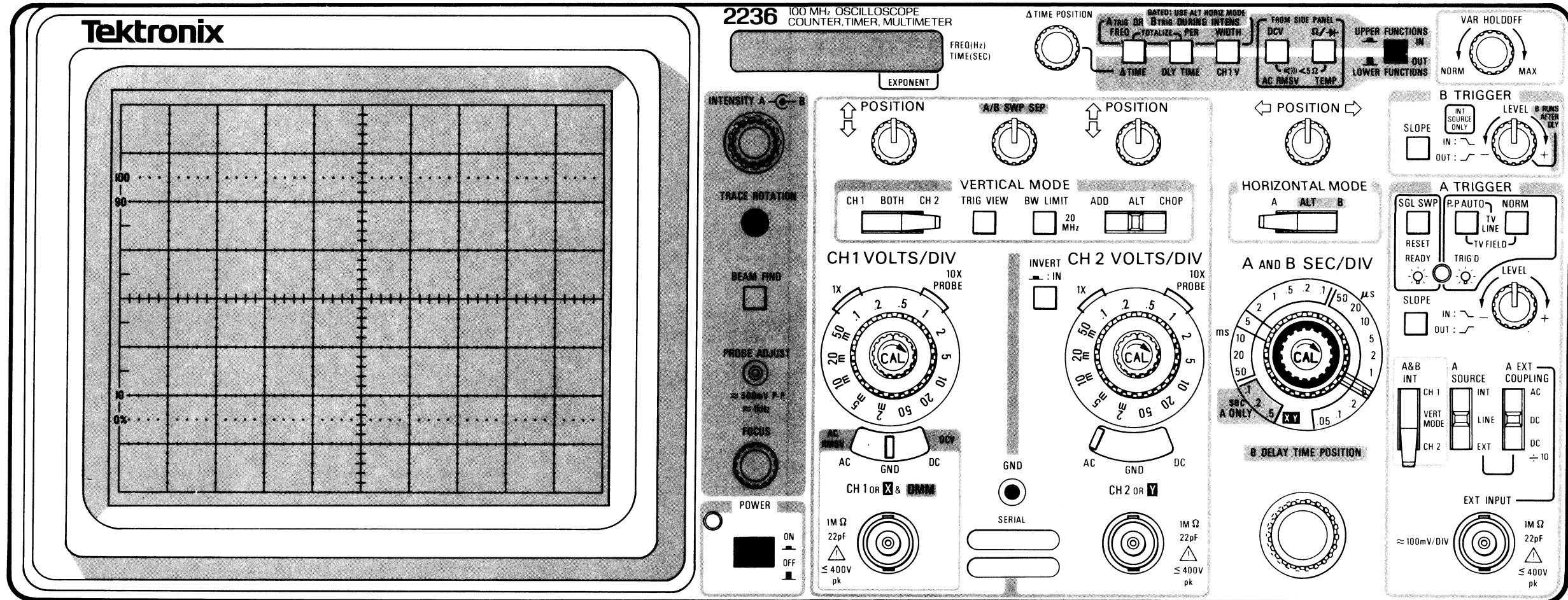
Qty	Description	Part Number
2	Probes, 10X 1.5-meter length with accessories	015-0468-00
2	Multimeter Test Lead Clips	020-0086-00
2	Multimeter Test Leads	012-0941-01
1	Operators Manual	070-4205-00
1	Power Cord	161-0104-00

OPTIONAL ACCESSORIES

The following optional accessories are recommended for use with the 2236 Oscilloscope.

Description	Part Number
Service Manual	070-4204-00
Protective Front Panel Cover	200-2520-00
Cord Wrap and Storage Pouch	016-0677-00
Protective Front Panel Cover, Cord Wrap, and Storage Pouch	020-0672-00
2 Probe Accessory, Grabber Tips	013-0191-00
Temperature Probe	010-6602-00
Rack-Mount Adapter Kit	016-0015-00
Low-Cost, General-Purpose Camera	Order C-5C Option 04
SCOPE-MOBILE Cart-Occupies less than 18 inches of aisle space, with storage area in base	Order 200C





Copyright © 1983, Tektronix Inc.
All rights reserved.

Limited license: Tektronix, Inc. grants permission
to reproduce this drawing as a visual aid for use
in instrument operator training.

4205-15